

Fuse Box

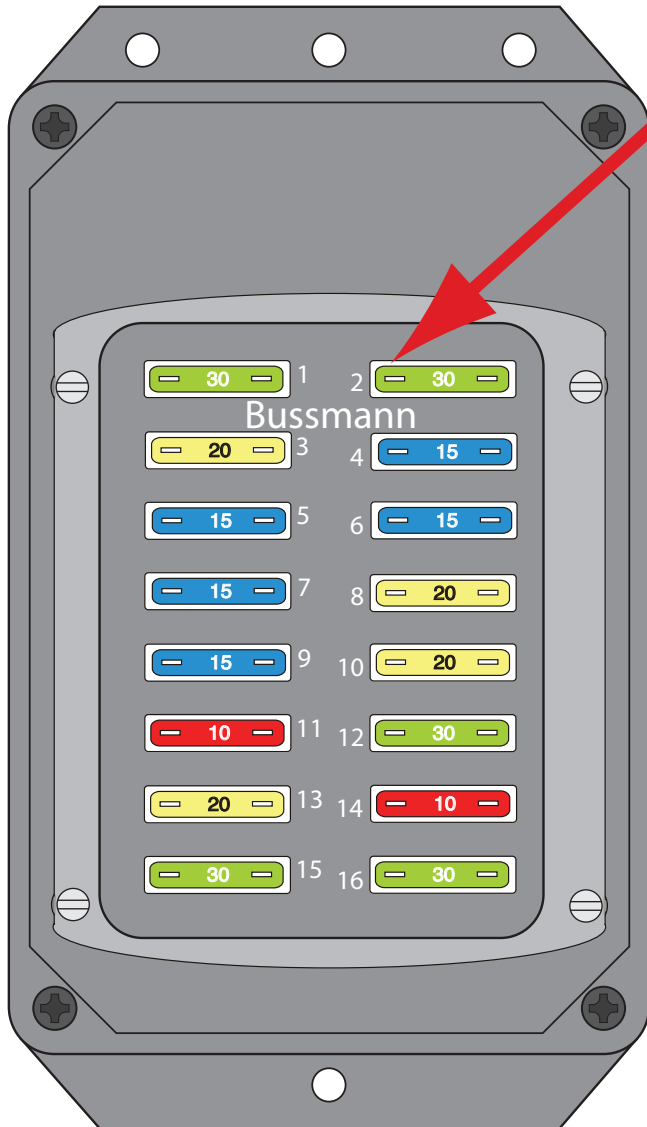

NOTE:

If your fuse box looks like this, these **ARE** the correct instructions for your application. If the word “Busmann” does not appear on the fuse box, you have a different version of this kit and these **ARE NOT** the correct instructions.

KIT BOX CONTENTS:

Bag	Part Number	Description	Quantity
	510054	Headlight Switch	1
	510469	Fuse, Relay, and Flasher kit	1
	500042	Dimmer Switch	1
	510053	Ignition Switch	1
	500919	Practice Terminal Crimping Set	1
G	510472	Dash Harness kit	1
H	510461	Instrument Cluster Wiring kit	1
J	510466	Engine Wiring kit	1
L	510465	Front Light Wiring kit	1
M	510462	Rear Body Wiring kit	1
Z	510476	Alt. & Main Power Connection kit	1
N	510131	Washer Wiper Wiring kit	1
	510473	Front Side Marker Connection kit	1



**American
Autowire**

www.americanautowire.com 856-933-0801

Classic Update Kit
1966-68 Mustang
510055

92974034 Rev. 0.0 03/22/2024



WARNING:

Validate the kit contents with the component list included on this page, before proceeding. This kit is intended to be used in a modified vehicle. Please read this page thoroughly and be sure that you understand everything explained on it prior to opening any of the enclosed packages, or before attempting to install any of the components. Once this kit has been opened or a component installed, the kit is not returnable.

1. This kit should typically be used in a **MODIFIED 1967-1968 Mustang** application only.
2. This kit only supports the use of a higher current self-exciting 1 wire, or other style internally regulated alternator. An adapter may be necessary for certain applications. **No stock alternators are supported.**
3. This kit **WILL NOT** support the use of a factory ammeter. All AAW kits are engineered to supply the optimum charge to the battery. To achieve this performance, we route our 6ga. charge wire directly from the alternator output terminal to the starter solenoid. Due to the path of the charge being altered from the stock configuration, the gauge can no longer see a charge vs. a discharge, so it will not work properly. When ammeters were originally used, most alternator current outputs were rated at maximum of about 25-60 amps. Modified cars being built today typically utilize a 100 amp or higher output alternator. With these higher current units, ammeters, generally speaking, become a safety hazard. Ammeters are usually wired in parallel to the charging circuit, are typically unfused, and can short very easily causing a fire. A voltmeter is recommended as a good alternative.
4. This kit **WILL NOT** support the use of a factory tachometer in it's original connection application as those tachs wired the primary ignition circuit directly in series through the tach and then out to the positive side of the coil. With this type of connection, any type of MSD or high energy ignition will generally destroy the internal circuitry of the tach and will cause the car to quit running as voltage will no longer flow through the tach and out to the coil or ignition control unit. **HOWEVER**, if your factory tach has been upgraded or retrofitted to a later style movement where the pulse post on the tach gets wired to the negative side of the coil (or to the tach output on an MSD box or similar unit) and the feed post of the tach uses a conventional 12 volt ignition connection, **you will be able to use this harness system.**
5. This kit **IS NOT** set up with a resistance wire for a standard, points type ignition system. It is wired with a full 12 volt primary ignition feed that is hot in both the start and run positions. It will support HEI, MSD, other electronic ignition systems, as well as computerized Fuel Injection systems. If you wish to run a points type system, there are illustrations on the engine connection pages (page 17 of this instruction set) to do so. Extra parts that are not included in this kit will be required to complete that operation.
6. This kit supports the use of, and supplies the wiring for, a factory heater only system. It also contains a 12 volt feed wire for use with the factory heater system, the factory A/C system (A/C harness wires are NOT included), or most aftermarket heat and A/C systems.

**510055 - Classic Update Series Kit
1967-68 Mustang**

This kit contains the following components:

Bag	Part Number	Description	Quantity
	510054	Headlight Switch	1
	510469	Fuse, Relay, and Flasher kit	1
	500042	Dimmer Switch	1
	510053	Ignition Switch	1
	500919	Practice Terminal Crimping Set	1
G	510472	Dash Harness kit	1
H	510461	Instrument Cluster Wiring kit	1
J	510466	Engine Wiring kit	1
L	510465	Front Light Wiring kit	1
M	510462	Rear Body Wiring kit	1
Z	510476	Alt. & Main Power Connection kit	1
N	510131	Washer Wiper Wiring kit	1
	510473	Front Side Marker Connection kit	1

Validate the kit contents with this component list. If there are any discrepancies with incorrect or missing parts, stop your installation and notify the supplier you purchased the kit from before proceeding.



**American
Autowire**

www.americanautowire.com 856-933-0801

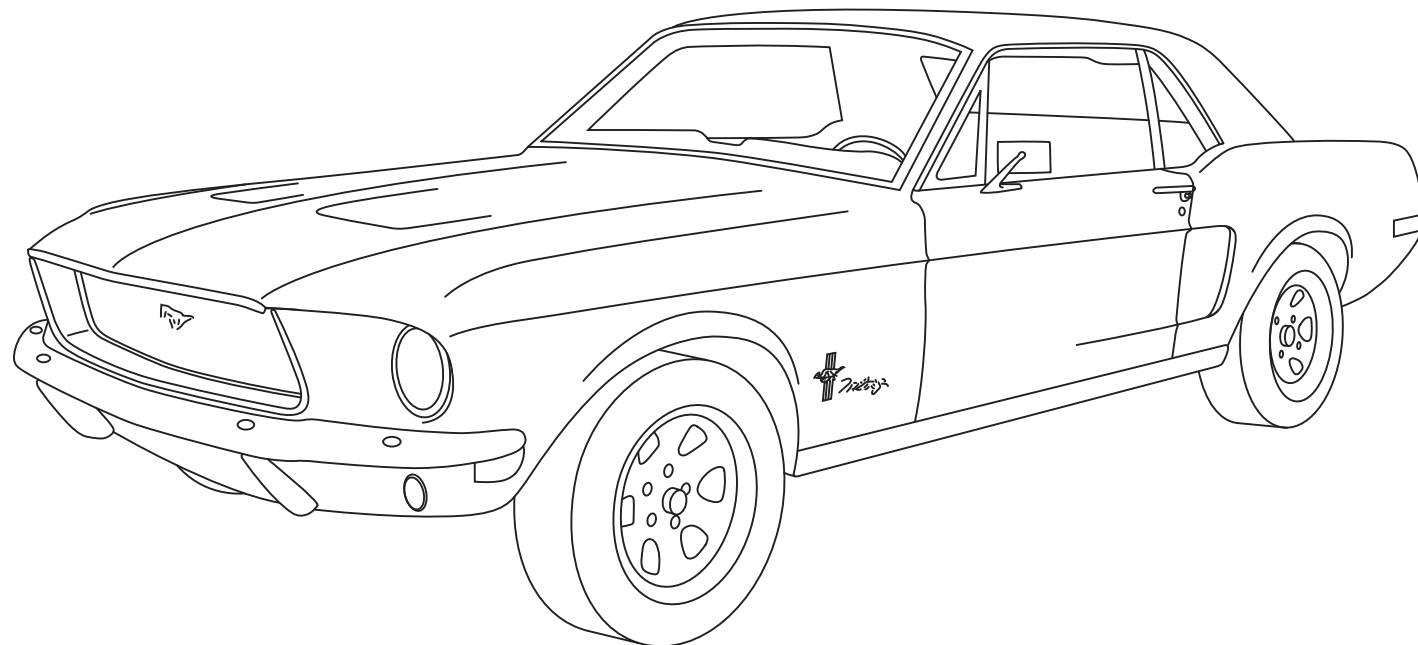

1967-68 Mustang
Classic Update Series
510055

© COPYRIGHT 2004 American Autowire / Factory-Fit
Used with express permission of
American Autowire / Factory-Fit

92972103 Rev 2.2 7/8/2022

START HERE !

PLEASE READ THIS BEFORE STARTING INSTALLATION !

This wiring kit is designed for ease of installation. Please read the guidelines below, BEFORE STARTING your installation, to guarantee a successful job. Use an appropriate crimping tool, which folds the wings of the open barrel terminals down into the wire, as shown on this page. If you use our crimping tools and correctly crimp the included terminals, soldering is not necessary. If you are unsure about a particular crimp, soldering is recommended. Our factory crimped terminations are installed by GM approved five ton presses, and soldering these terminations is not necessary.



AAW offers a great terminal crimping video entitled "Proper Crimping Video". It can be viewed by visiting YouTube.

Type the following address into your web browser, to go directly to the video:
www.youtube.com/watch?v=JAgEDoVI-co

Youtube Channel:
www.youtube.com/user/WiringHarness



The terminals that we supply in our kits, utilize what is known as an F crimp. The F crimp, in a cross section, will look like the illustration below, when done correctly.

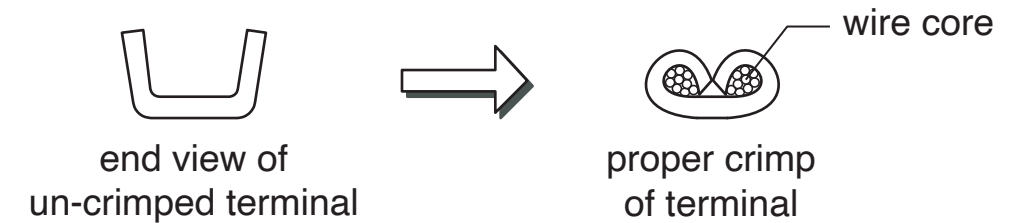

We carry the following crimping hand tools, to help with your terminal crimping. These hand tools are available, for purchase or rental.



We carry many accessories for your 1967-68 Mustang:

Split Braid Harness Wrap

- p/n 510152 1/4" x 10'
- p/n 510153 1/4" x 15'
- p/n 510154 3/8" x 10'
- p/n 510155 1/2" x 10'
- p/n 510156 3/4" x 10'
- p/n 510157 1.0" x 10'

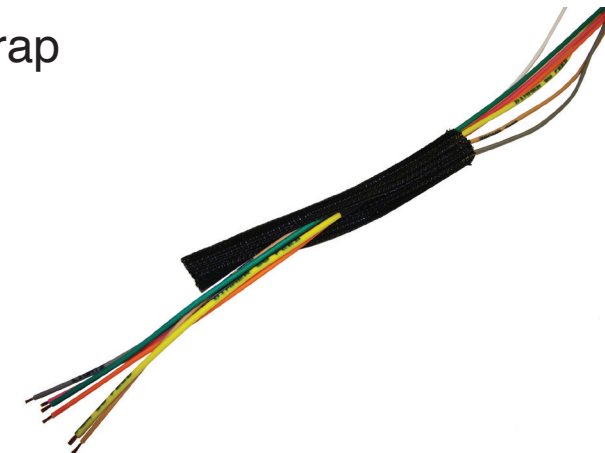

p/n R0067108
OEM style non-stick
harness tape

STEP 1: DISCONNECT YOUR BATTERY:

Disconnect the battery, before installing the wiring kit, to prevent any accidental shorting caused by loose or bare wire ends.



If you have any questions concerning this or any of our products, please feel free to call us at 1-856-933-0801.

STEP 2: START INSTALLING KIT:

This kit is broken down into individual sections, that are identified by a letter printed on the enclosed sheets, visible through each bag. The order of installation and the pages with their installation instructions, are shown below:

Table of Contents:

Bags: Pages: Sections:

- G 4 - 10 Dash Harness - This is the main harness in the kit and contains:**
- Heater feed and switch, radio, horn and lamp relay connections.
 - Door jamb switch, door courtesy and rear body harness connections.
 - Ignition, lighting, dimmer, brake, turn signal switch and wiper feed connections.
 - Neutral safety and back up light switch connections, console connections.
- N 6 and 8 Washer/Wiper Harness - This Harness contains:**
- Windshield wiper and washer coordinator harness assembly.
- H 11 - 15 Gauge Cluster Harness - This Harness contains:**
- Gauge connections for aftermarket and factory gauges.
- J 16 - 17 Engine Harness - This Harness contains:**
- Temperature, oil pressure, tachometer wiring.
 - Ignition system / ECU power.
 - Alternator connections.
 - Starter solenoid connections.
 - Main panel feed connections.
- Z 16 - 17 Alternator and Main Power Kit - This Harness contains:**
- Megafuses, hardware, terminals and 6 ga. alternator charge wire.
- L 18 - 19 Front Light Harness - This Harness contains:**
- Headlight, turn signal, running light, front side marker light connections.
 - Electric fan relay trigger.
 - Fog light connections.
 - Brake warning light connections.
 - Horn connections.
- M 20 - 21 Rear Body Harness - This Harness contains:**
- Tail light, turn signal, reverse light, running light and third brake light connections.
 - Fuel tank sender connections.
 - Dome light connections.



www.americanautowire.com 856-933-0801

1967-68 Mustang
Classic Update Series
510055 92972103 Rev 2.2 7/8/2022

PLEASE READ THIS HELPFUL INSTALLATION TIP, BEFORE GOING ANY FURTHER!

Prior to installing the Dash/Main harness in your dashboard, plug all of the fuses (510469 kit) into the Fuse Box (see detailed picture below) and the Hazard and Turn Flashers into the harness. The Headlight, Fog Light and Horn Relays will plug into the harness after you mount the relay bank to the wiper motor support bracket. (see detailed pictures below).

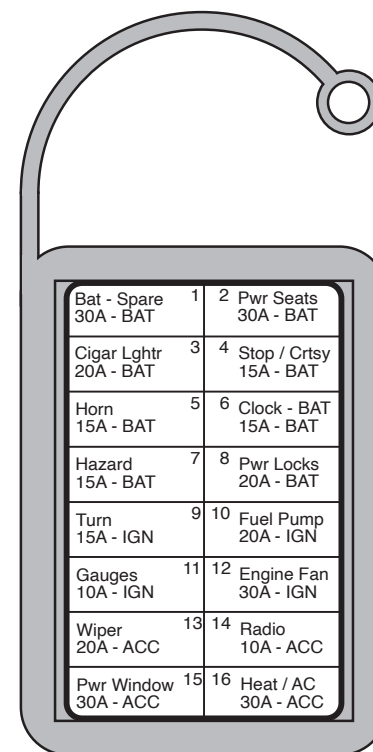

Fuse label
on inside
of Fuse
Box cover

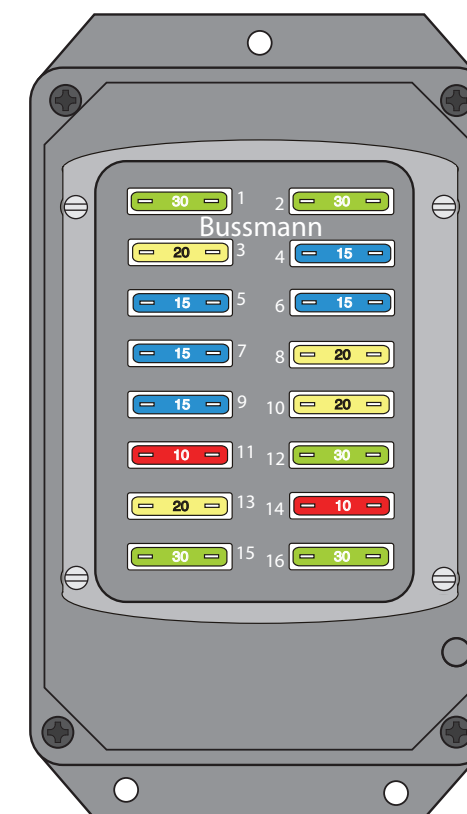

Fuse
Installation
Locations

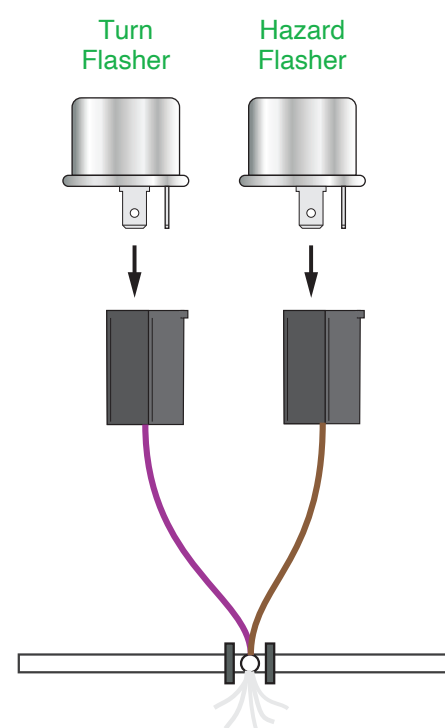

Headlight, Fog Light and Horn Relays
(NOTE: DO NOT plug the relays in until
after you have mounted the relay bank
to the wiper motor support bracket)

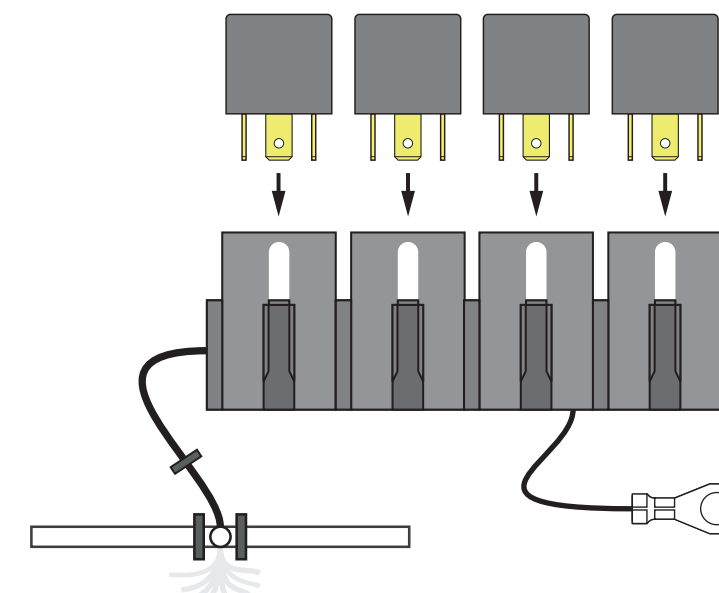

Dash/Main harness installation instructions:

Shown below, are the supplied misc. terminals, plastic connector bodies, hardware, jumpers and extensions, included in the Dash/Main Harness and Loose Piece bag (510472) 92972131 that will be used to complete your Dash/Main harness connections. They are itemized and referred to on this page, just as they are on the following pages of this Dash/Main instruction set.

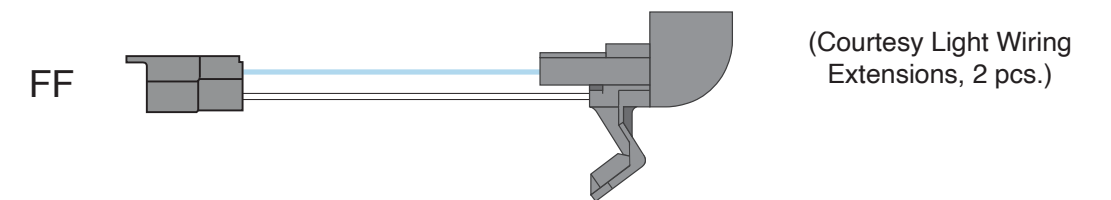
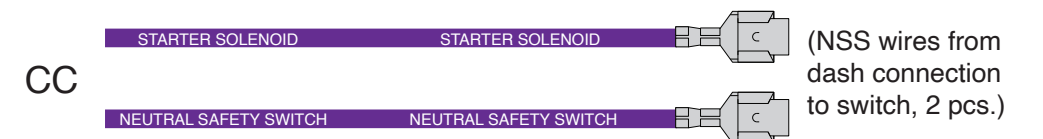
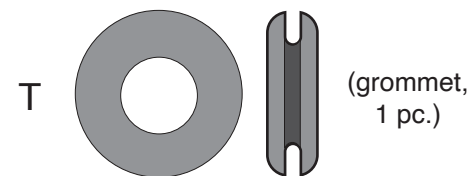
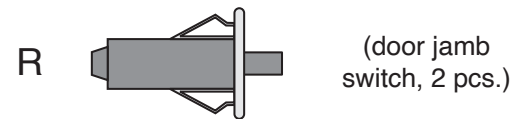
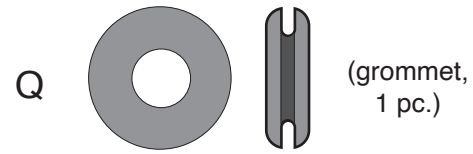
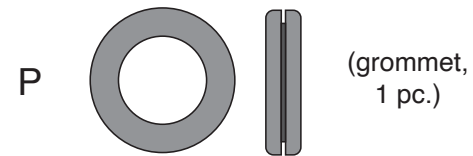
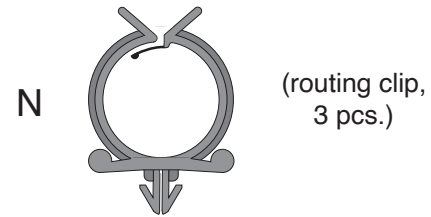
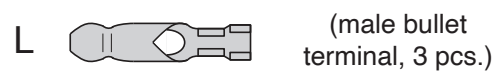
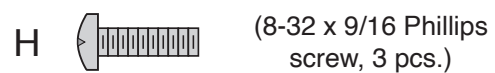
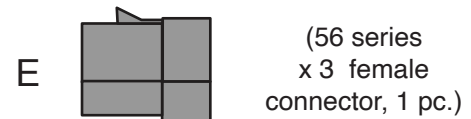
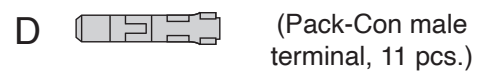
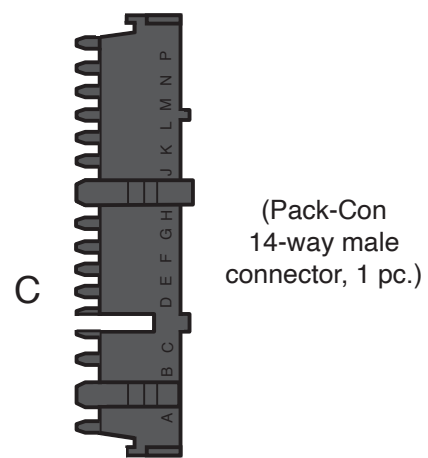
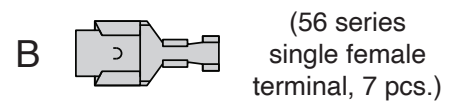
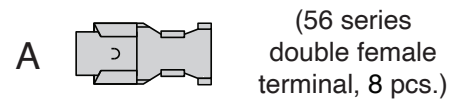

Dash/Main fusebox /bracket/ harness assembly mounting instructions:



www.americanautowire.com 856-933-0801

1967-68 Mustang
Classic Update Series
510055 92972103 Rev 2.2 7/8/2022

1. Prior to installing the dash harness into the car, be sure you have installed all of the fuses into the fusebox (see top of page 3). See fuse panel mounting instructions 92972201 and Items 1 and 2 on this page for detailed installation instructions on the mounting of the fuse panel assembly. Route the harness as shown in pics 1 - 6, and items 3 - 12 on this page.
2. Mount relay bank to wiper motor support bracket, then plug in the relays. See #2 at right, and template 92972156 for details.
3. Plug the white wiper feed wire from the AAW dash harness into the new 510131 wiper harness as shown on pages 6 and 22 of this instruction set. The wiper switch connector will plug onto the wiper switch when you install the cluster assembly into the dash; the wiper motor connector will plug onto the motor assembly; the washer leads will plug onto the coordinator (see pg. 22).
4. Plug ignition switch 510128 into harness connector, attach brown wire with ring terminal to the threaded stud, plug tan wire onto ground blade of the ignition switch and install completed assembly into your dash (see switch instructions). Plug in your cigar lighter connection. Plug H/L switch 510054 into harness connector and install into your dash (see switch instructions).
5. Route the front light, engine and dimmer switch connections back around the fresh air vent as shown in #'s 4 and 5 below so that they are at the pass-through opening in the firewall, then route the dimmer switch connection down to the floor area and attach to dimmer switch 500042. Secure dimmer switch to the toeboard/floor. Plug in front light wiring 510465, and engine wiring 510466. After installing firewall grommet "T" in the pass-through opening in the firewall, route the engine and front light wires out into the engine bay. See pages 16, 17, 18 and 19 for installation details.
6. Drop rear body harness lead and LH doorjamb switch wires down inside the LH door hinge pillar as shown in # 6 below. Make LH door switch and courtesy lamp connections. See pages 6 and 9 for details. Plug in your rear body harness 501462, then route the wires along the door sill back to the trunk area. See pages 20 and 21 for connection details.
7. Plug brake switch connection onto your existing brake switch. See page 6.
8. Assemble the NSS and B/U switch extension (items BB, CC and GG from page 4) and plug onto dash harness connection. See pages 6 and 10 for detailed installation instructions.
9. Plug in your steering column connections. See pages 6 and 8 for detailed installation instructions.
10. Build your gauge cluster harness, then plug the finished assembly into the dash harness connections as shown on page 6. See pages 11-15 for details on building your cluster harness. Please note that there are several different choices and be sure you have picked the proper choice for your car's application.
11. Build your stock heater connections. Note the installation of firewall grommet "S" from page 4. See page 10 for details.
12. Pass remaining harness over past the radio and heater controls to the RH side of the car. Make the radio, console, glove box, RH door switch and courtesy lamp connections as necessary. Attach the instrument cluster ground wire to the metal dash assembly. See pages 7 and 9 for details.



1. Mount the loaded fusebox assembly in the same general location as your original and as shown above using screws, nuts and washers "H, J and K" found in the 510472 dash loose piece kit. Route the harness up through the existing loop clamp and along the side of the wiper motor and bracket assembly.

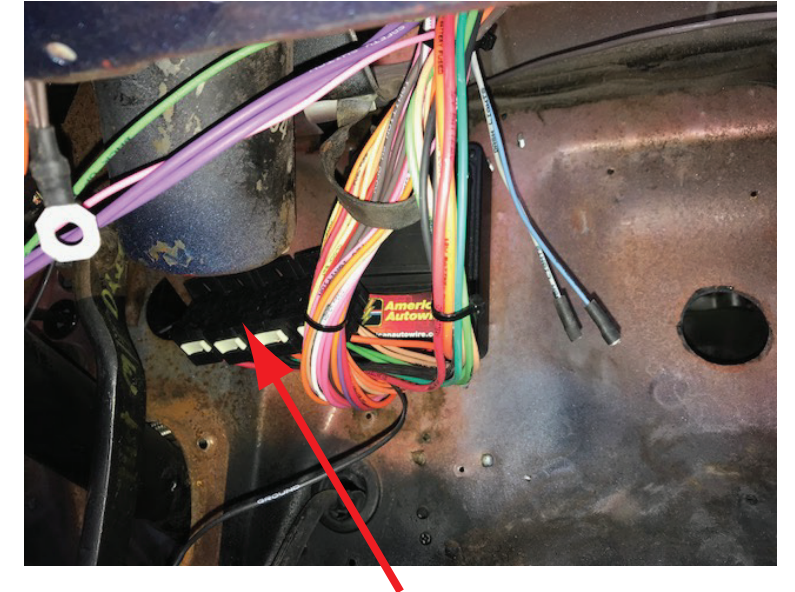

2. Using the "Relay Bank Mounting Template" and instruction sheet 92972156, drill two new .125 mounting holes in the windshield wiper motor bracket and attach the relay bank to the bracket as described on the instruction set and as shown above.

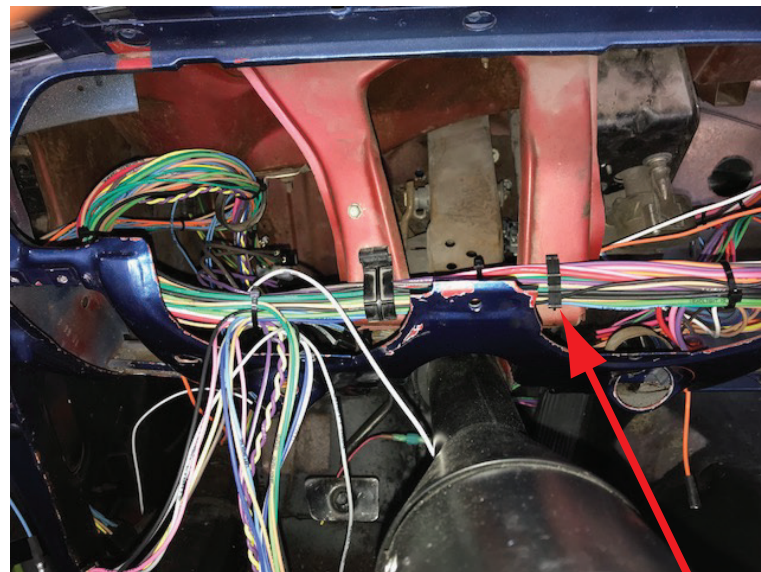

3. With the cluster and original wiring removed, route the new "dash harness" away from the firewall and through the opening between the wiper motor bracket and steering column, then down across the bottom of your dash, through provided clips "N" (in case your originals are missing or damaged), and above your steering column as shown above.

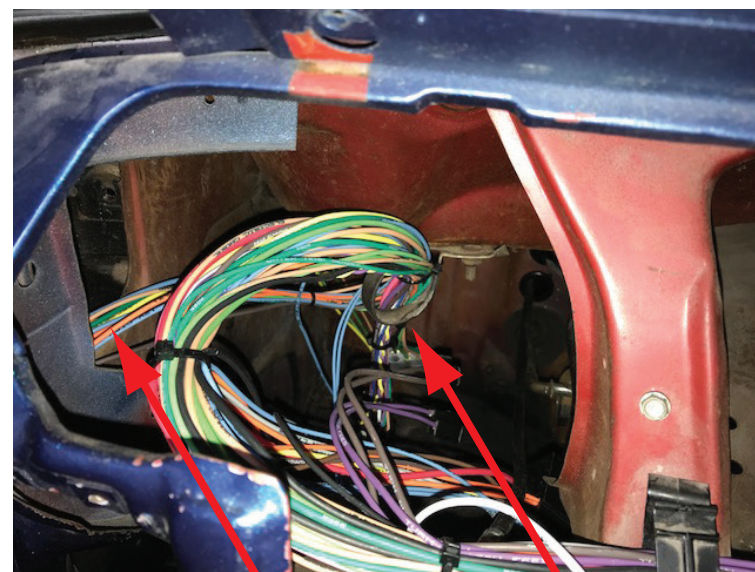

4. Route the harness assembly around the left side to the LH door hinge pillar area. Your rear body and LH door jamb switch wires will route down through the door jamb A-pillar as shown in #6. The engine and front light harness disconnects, the LH courtesy lamp plug, and your dimmer switch connection route through the existing loop clamp at the air vent box as shown above. (Air vent box removed for photo)

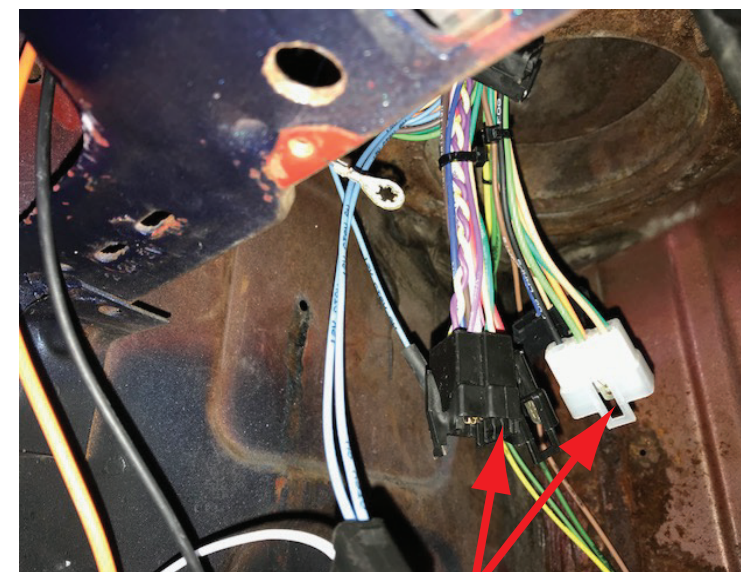

5. Your engine (510466) and front light (510465) harnesses will plug onto these 4 dash leads, will route out to the Engine Compartment. The final connection details are shown on pages 16,17, 18 and 19 of this instruction set.

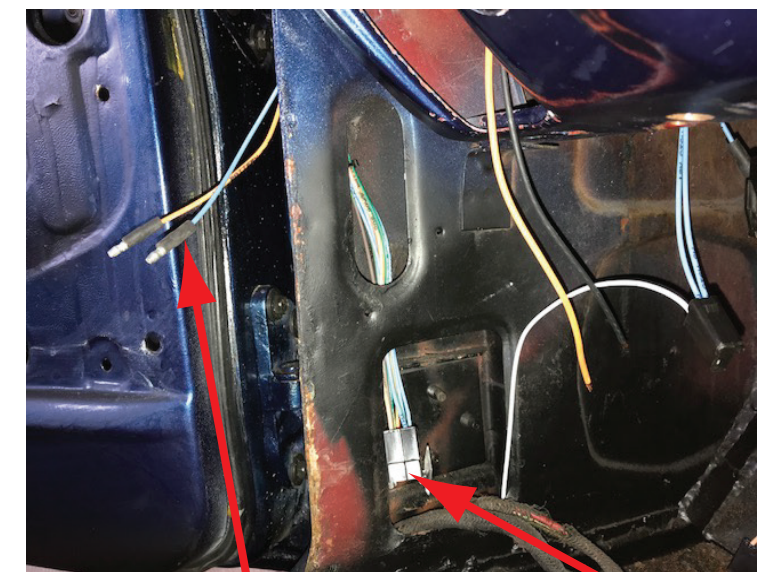

6. Your LH doorjamb switch wires and rear body harness leads route through an opening in the top of the LH door pillar area. The doorjamb switch wires route out the doorjamb switch opening and will plug into the provided doorjamb switches (pg 9). Similar operation for the RH side wires. The rear body harness (510462) will plug onto the dash lead down inside the LH door pillar as shown above.

Dash/Main harness installation instructions:

510131 Wiper Harness Assembly (plug the new wiper harness assembly onto the white "wiper feed" wire)

NOTE: Your NEW AAW dash harness includes a white 12v power feed wire (wiper feed) that will plug into your new 510131 wiper and washer harness. See page 22 for more detailed wiper and washer harness information.

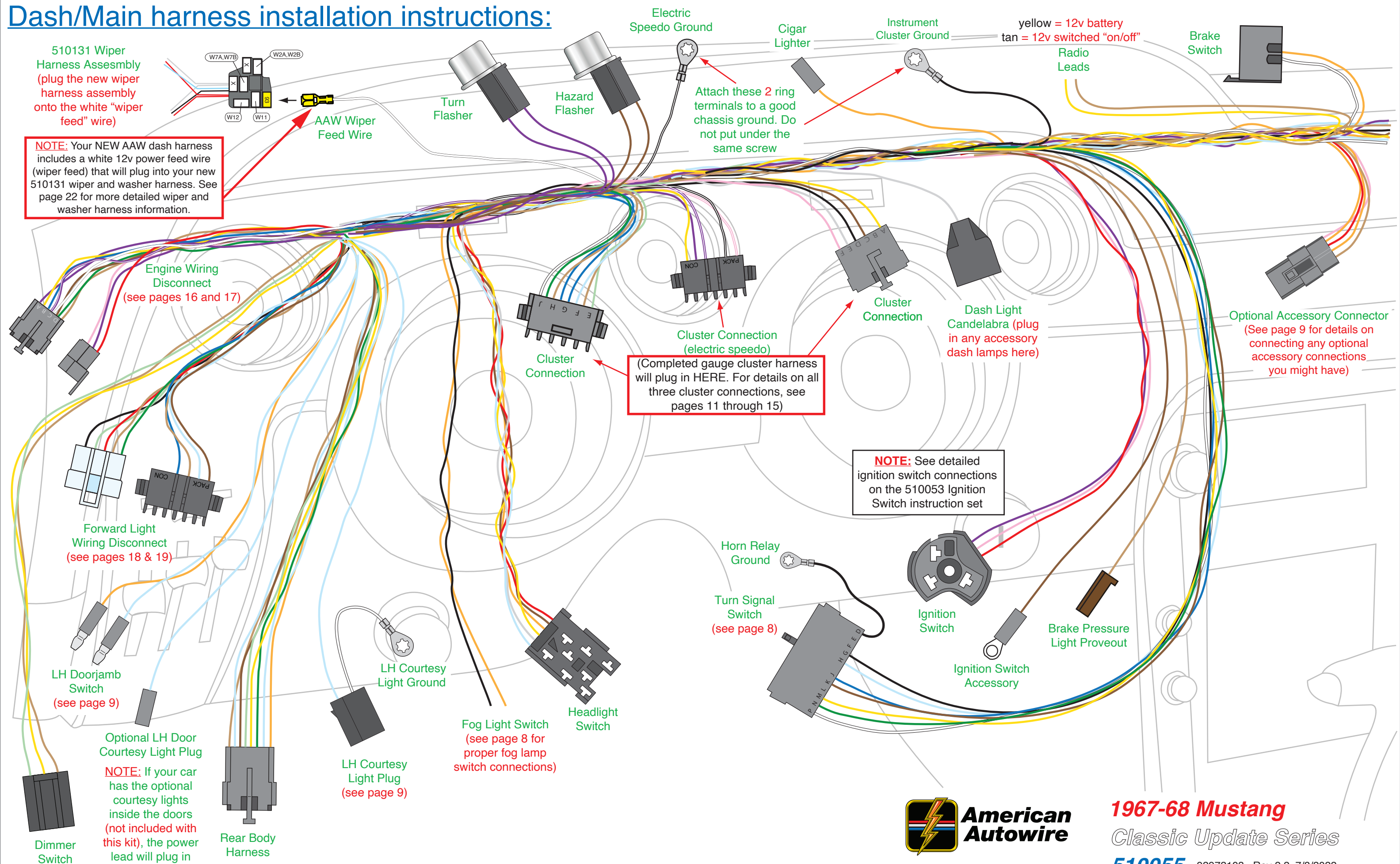

yellow = 12v battery
tan = 12v switched "on/off"

Attach these 2 ring terminals to a good chassis ground. Do not put under the same screw

(Completed gauge cluster harness will plug in HERE. For details on all three cluster connections, see pages 11 through 15)

NOTE: See detailed ignition switch connections on the 510053 Ignition Switch instruction set

NOTE: If your car has the optional courtesy lights inside the doors (not included with this kit), the power lead will plug in here.

Dash/Main harness installation instructions:

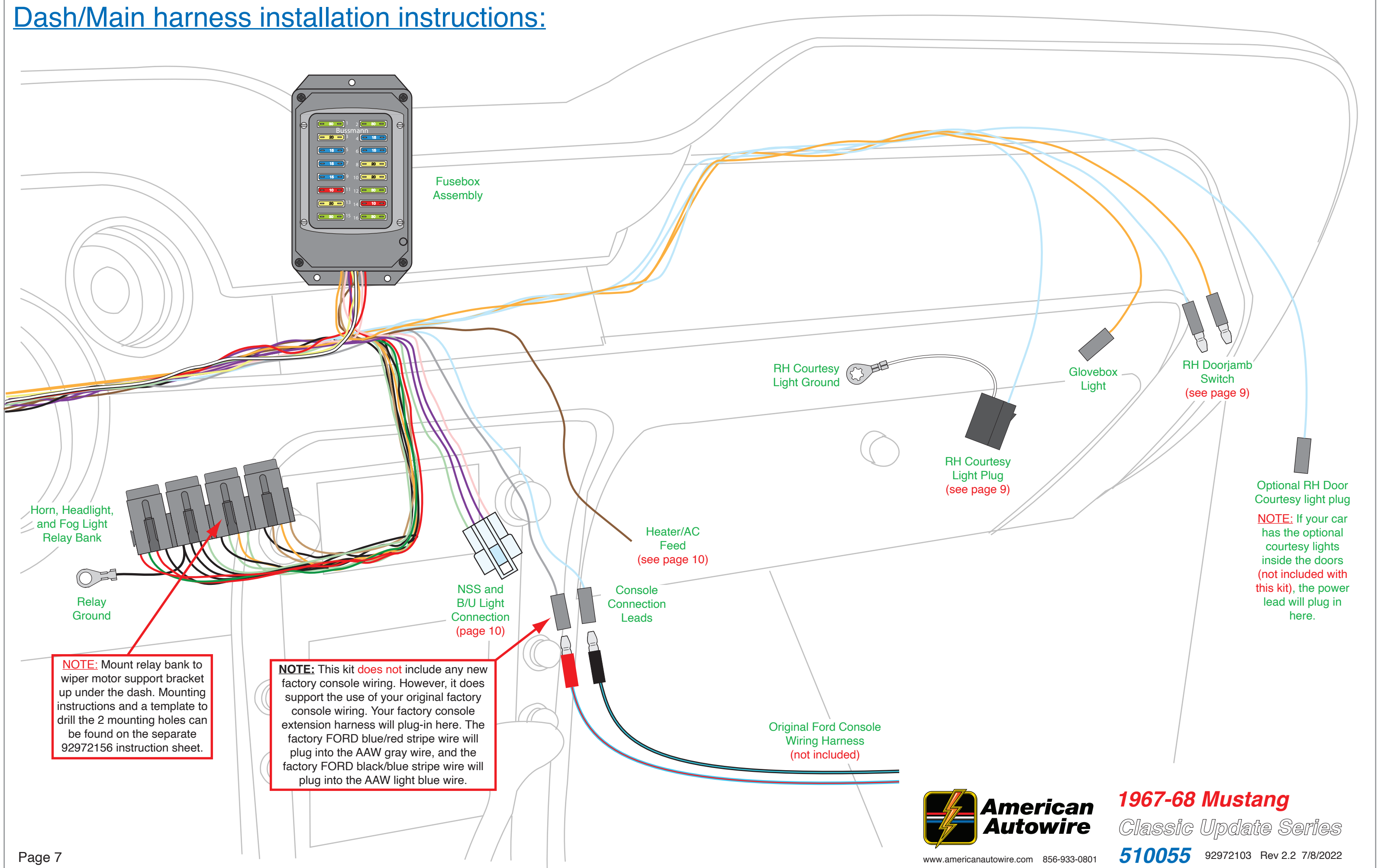

NOTE: Mount relay bank to wiper motor support bracket up under the dash. Mounting instructions and a template to drill the 2 mounting holes can be found on the separate 92972156 instruction sheet.

NOTE: This kit **does not** include any new factory console wiring. However, it does support the use of your original factory console wiring. Your factory console extension harness will plug-in here. The factory FORD blue/red stripe wire will plug into the AAW gray wire, and the factory FORD black/blue stripe wire will plug into the AAW light blue wire.

Optional RH Door Courtesy light plug
NOTE: If your car has the optional courtesy lights inside the doors (not included with this kit), the power lead will plug in here.



faces towards rear of car

NEW .125
DIA HOLES
2 PLACES

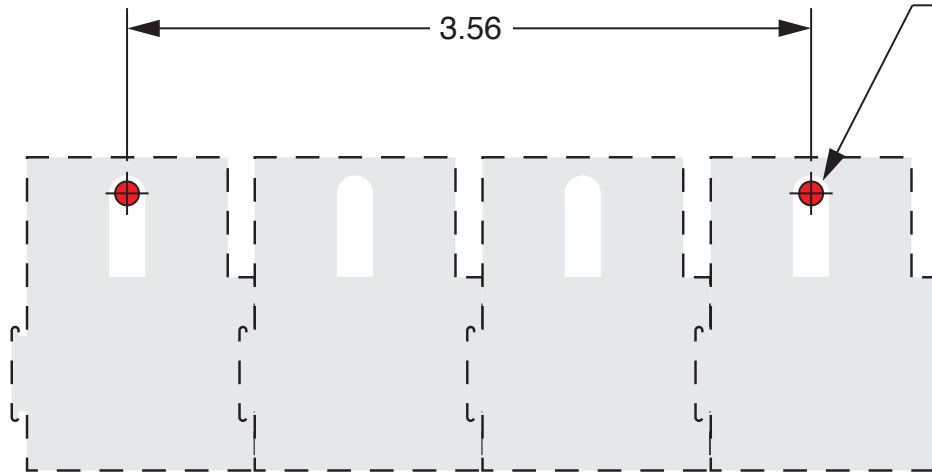

faces towards front of car

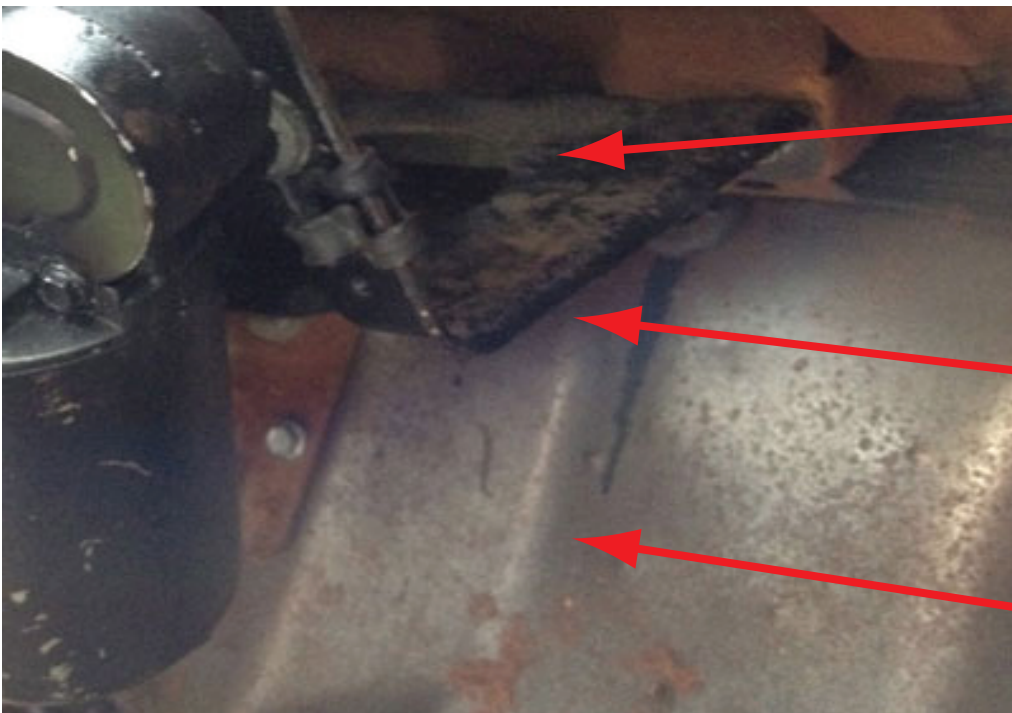

Wiper motor
support bracket

Your 4-way relay
bank will install
from the right side
and will mount to
the underside of
the wiper motor
support bracket.

Firewall/Toeboard

1. Use the template at the top of this page to drill two .125 mounting holes in your wiper motor support bracket to mount the bank of 4 relays (**screws not included**).

2. The 4-way relay bank shown on the main instruction set, **92972102**, will mount here with the wiring portion coming out toward the passenger side of the car.

3. Once you have mounted the relay bank, plug the 4 relays into the relay bases to complete this part of the installation.

**PRINT ON ADHESIVE
LABEL SHEET**

92972156

1964-68 Ford Mustang relay bank
mounting template instructions

Rev 0.0 7/16/2018

PRINTING INSTRUCTIONS: **DO NOT FIT TO PAGE OR SCALE**

Dash/Main harness installation instructions:

Turn signal switch wiring:

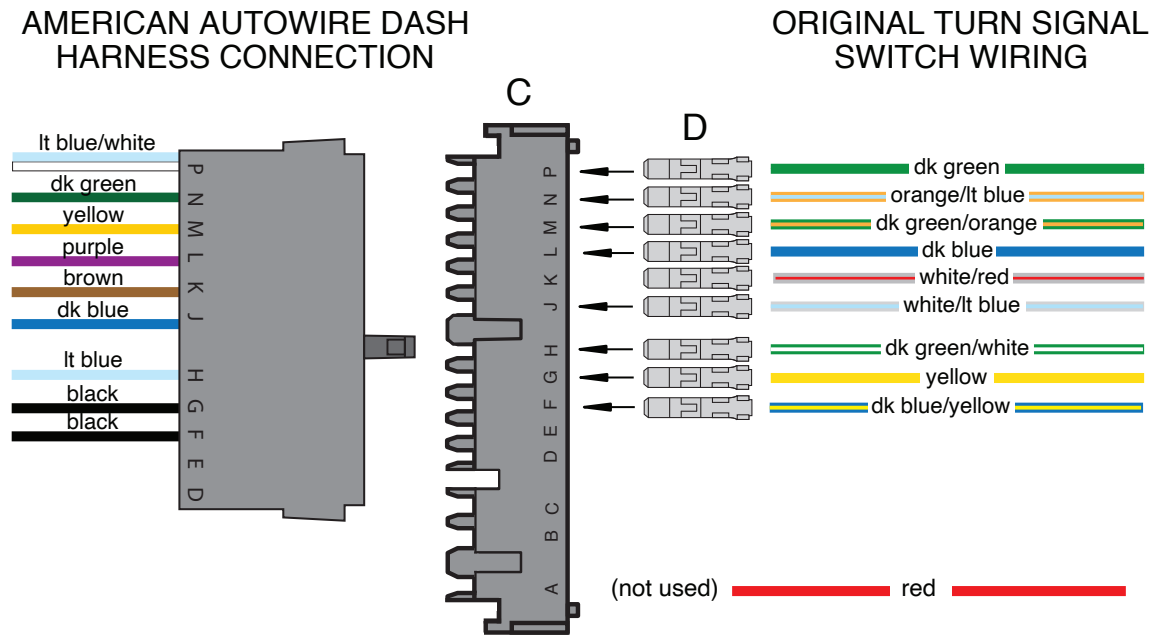

DIAGRAM 'A' - AAW Turn Signal Switch Wires to Stock 1967-68 Steering Columns.

"Table B"

AAW Turn Signal Connection wires to stock 1967-68 Ford Mustang Turn Signal Switch wires

AAW Wire Color	AAW Wire Printing	AAW Connector Cavity	FORD Wire Color
Lt Blue/White	Third Brake Light/Brake SW	P	Dark Green
Dark Green	Right Rear Turn	N	Orange/Lt. Blue
Yellow	Left Rear Turn	M	Dk. Green/Orange
Purple	Turn Switch Feed	L	Dark Blue
Brown	Turn SW – Hazard	K	White/Red
Dark Blue	Right Front Turn	J	White/Lt. Blue
Light Blue	Left Front Turn	H	Dk. Green/White
Black	Horn Relay Ground	G	Yellow
Black	Horn Relay Ground	F	Dk. Blue/Yellow
None	None	E	
None	None	D	
None	None	A	(Red - Not Used)

Remove the original Turn Signal Switch Connector and replace it with the AAW 14-way connector "C". Crimp terminal "D" onto each of the original Turn Signal Switch wires and plug them into connector "C" (see Parts Kit 92972131). **(NOTE: Some replacement turn signal switches have a red wire in them that will not be used in this application)**

See "Table B" above to align the wires. Also, for all of the '67-'68 applications, the steering column horn button now switches ground for the Horn Relay, which then switches power to the Horns.

Fog light switch wiring: (Note: 1967 switch is shown, 68 connections are the same)

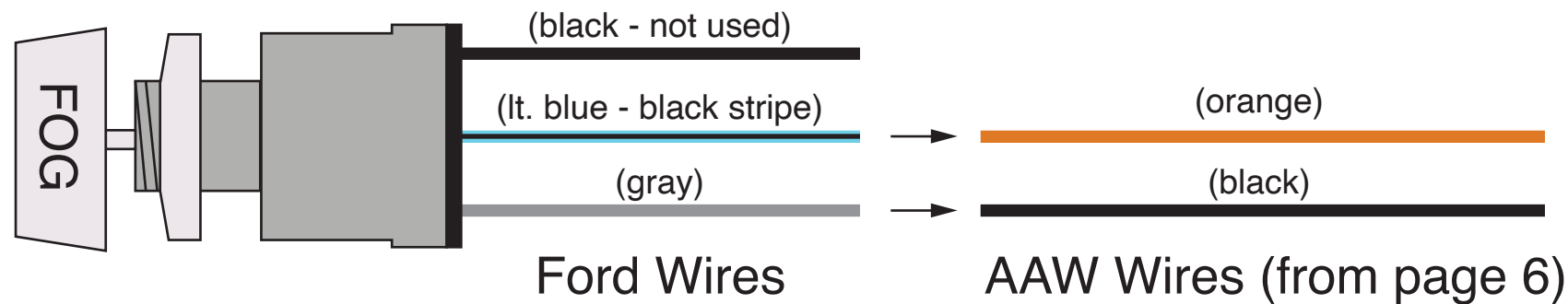

NOTE: The factory Ford fog lamp switch utilized 3 wires: blue with a black stripe, gray, and black. For this application, the AAW orange wire will be connected to the original Ford blue with black stripe wire, and the AAW black wire will be connected to the original Ford gray wire. The original Ford black wire will not be used in this application and should be capped off.



www.americanautowire.com 856-933-0801

1967-68 Mustang
Classic Update Series

510055 92972103 Rev 2.2 7/8/2022

Dash/Main harness installation instructions:

Accessory connector wiring:

Use the provided 6-way empty connector, which is attached to the 6-way Accessory connector on the Dash Harness, and terminals "A" or "B" to add power wires (not included in kit) for the following optional systems:

Wire Color	Printing	Fuse #	Fuse Block Cover	Fuse rating	Description
Tan	FUEL PUMP	10	Fuel Pump	20A	Fused 12 volt IGNITION feed for fuel pump (may also be used to feed power to another ignition circuit).
Orange	POWER SEATS	2	Pwr Seats	30A	Fused 12 volt BATTERY feed for power seats (may also be used to feed power to another battery circuit).
Red	POWER LOCKS	8	Pwr Locks	20A	Fused 12 volt BATTERY feed for power door locks (may also be used to feed power to another battery circuit).
Pink	POWER WINDOWS	15	Pwr Window	30A	Fused 12 volt ACCESSORY feed for power windows (may also be used to feed power to another accessory circuit).
Orange	(No Printing)	7	Bat-Spare	15A	Fused 12 volt BATTERY feed (may also be used to feed power to a battery circuit).

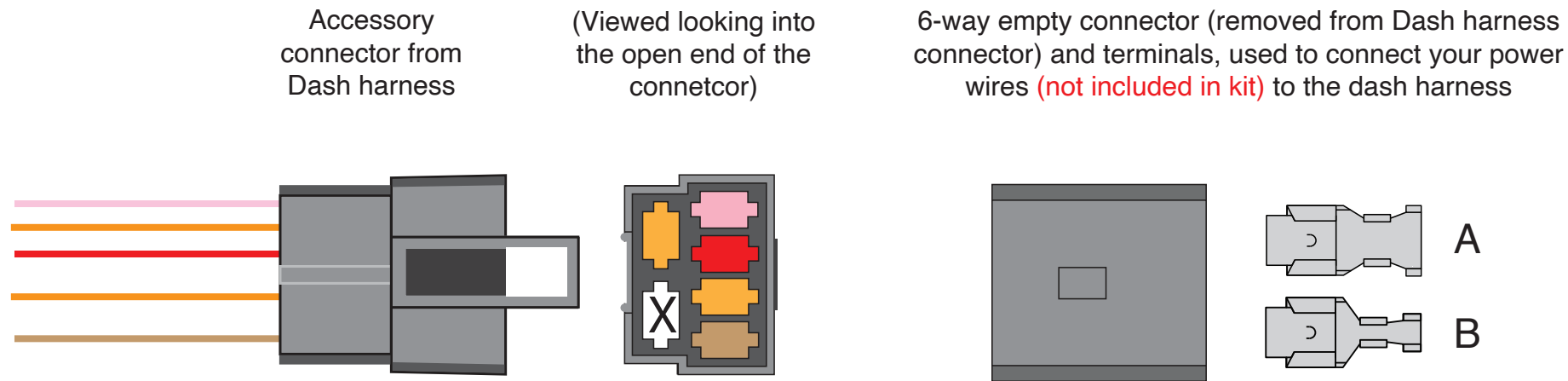

Courtesy light wiring:

Connect the (2) courtesy light wiring extensions "FF" to the courtesy light plugs from the dash harness: The left-hand courtesy plug is at the same branch as the rear body connection, and will mount to the left of the steering column along the bottom of the dash. The right-hand courtesy plug is at the far end of the dash harness, near the glovebox lamp connection and RH door jamb switch connections, and will mount along the bottom right of the dash. The (2) courtesy light wiring extensions are found in the dash loose piece bag, part number (510472) **92972131**.

(2) courtesy light connections from Dash harness

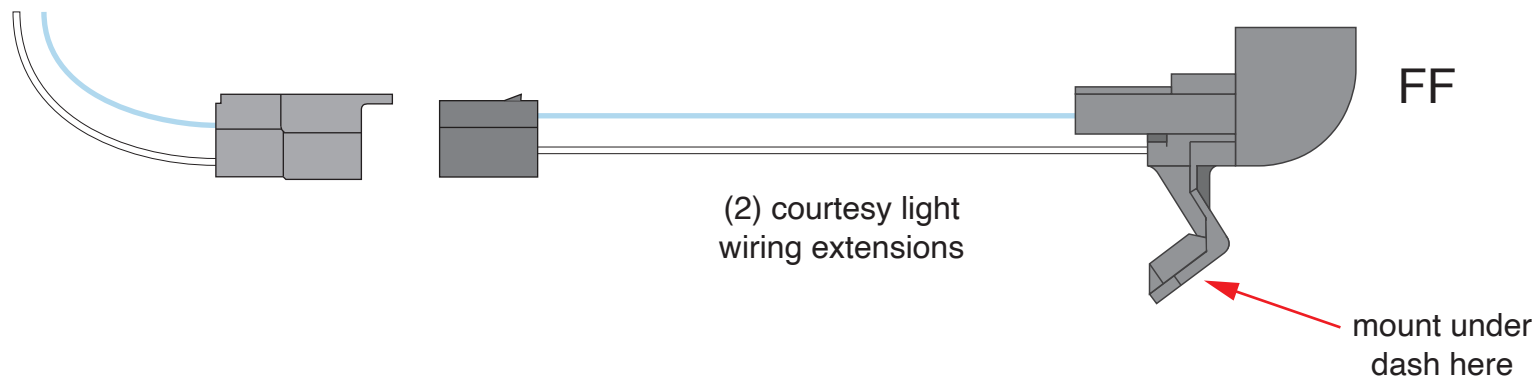

Doorjamb Switch Connections:

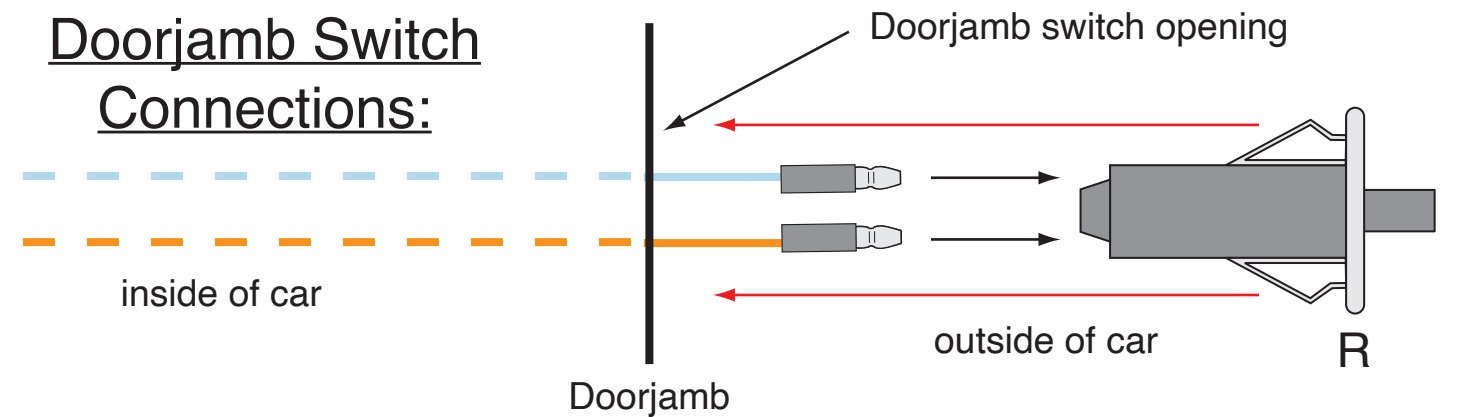

NOTE: Your doorjamb switch wires route down through the LH and RH pillars and out through the doorjamb switch openings. Pull the wires out as shown in #6 on page 5 and as above, plug them into your new doorjamb switches "R" from page 4, then snap the plugged-in switches back into the door jamb switch openings. Repeat for LH and RH sides of the dash.



www.americanautowire.com 856-933-0801

1967-68 Mustang
 Classic Update Series
510055 92972103 Rev 2.2 7/8/2022

Dash/Main harness installation instructions:

Neutral Safety Switch and Backup Switch wiring:

Manual Trans:

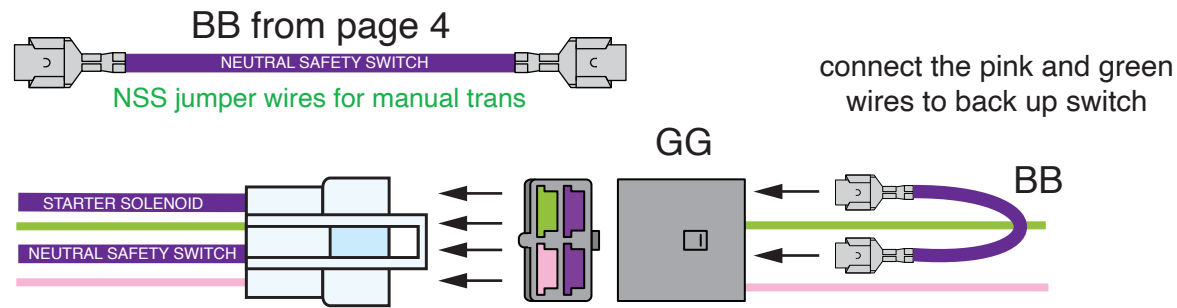

NSS and Back Up light connector from Dash harness (from page 7)

OR

Automatic Trans:

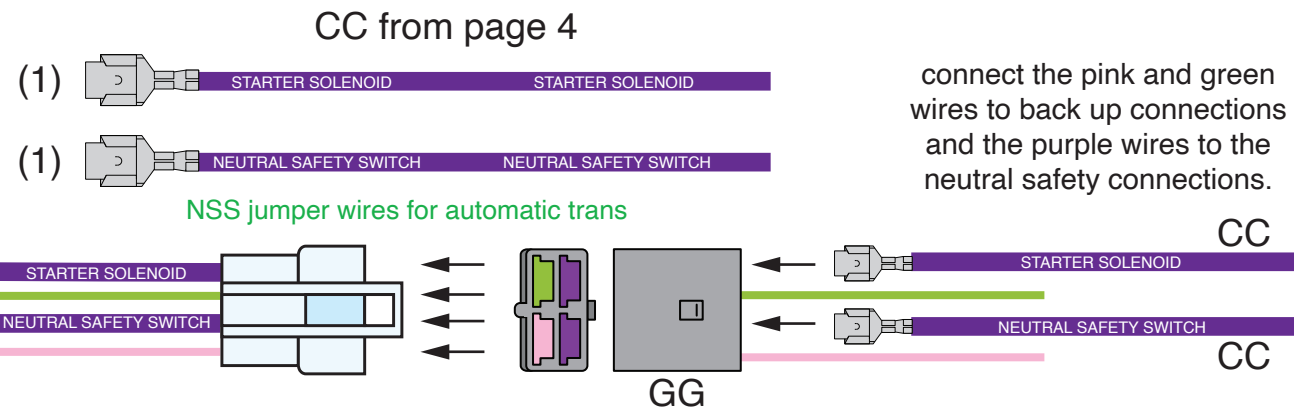

NSS and Back Up light connector from Dash harness (from page 7)

Automatic Trans cont'd:

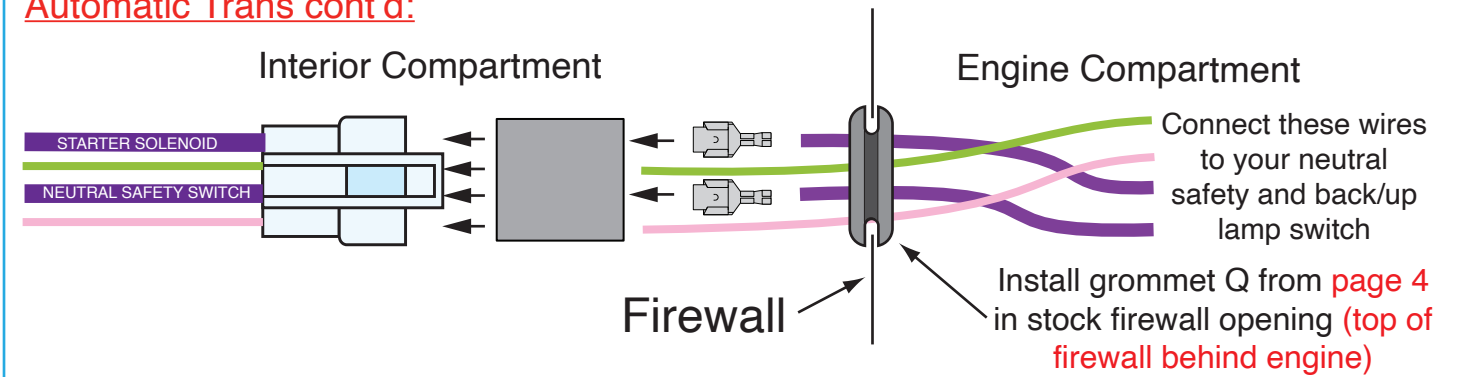

Shown is a typical Ford NSS and Back Up Switch.

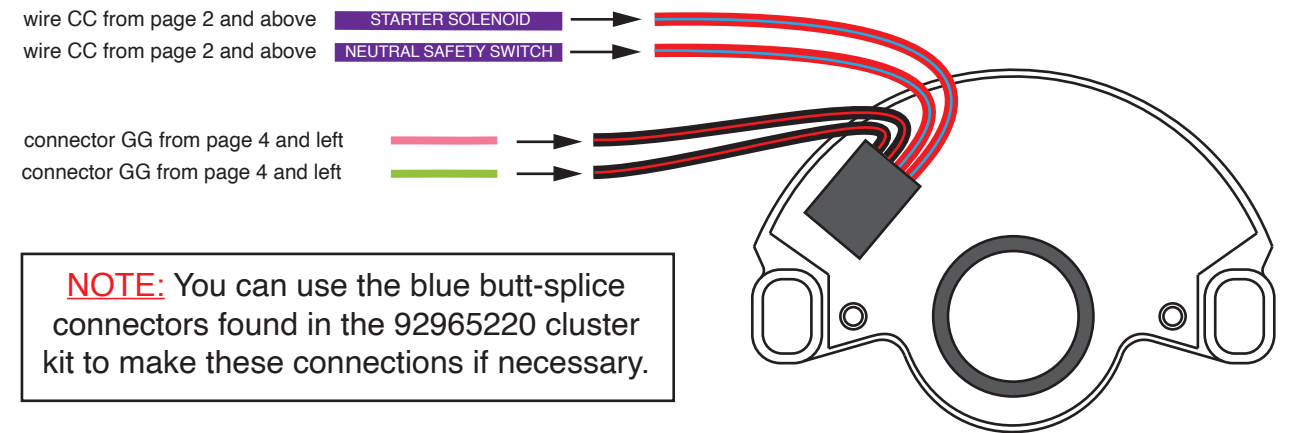

Heater wiring: 3 Speed Heater Motor Connections

(original heater switch and wiring. Cut the connector off here)

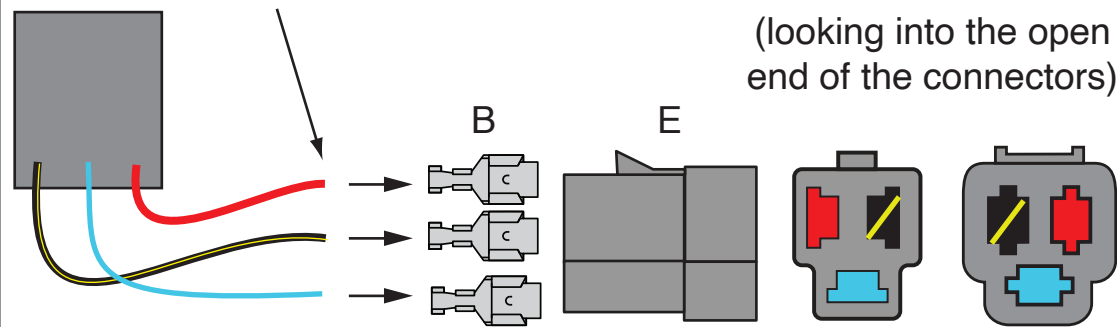

NOTE: Cut connector off of the original heater control switch, crimp on terminals B, and plug into connector E as shown above. Be sure to maintain color continuity between connector E and the heater switch to resistor harness HH

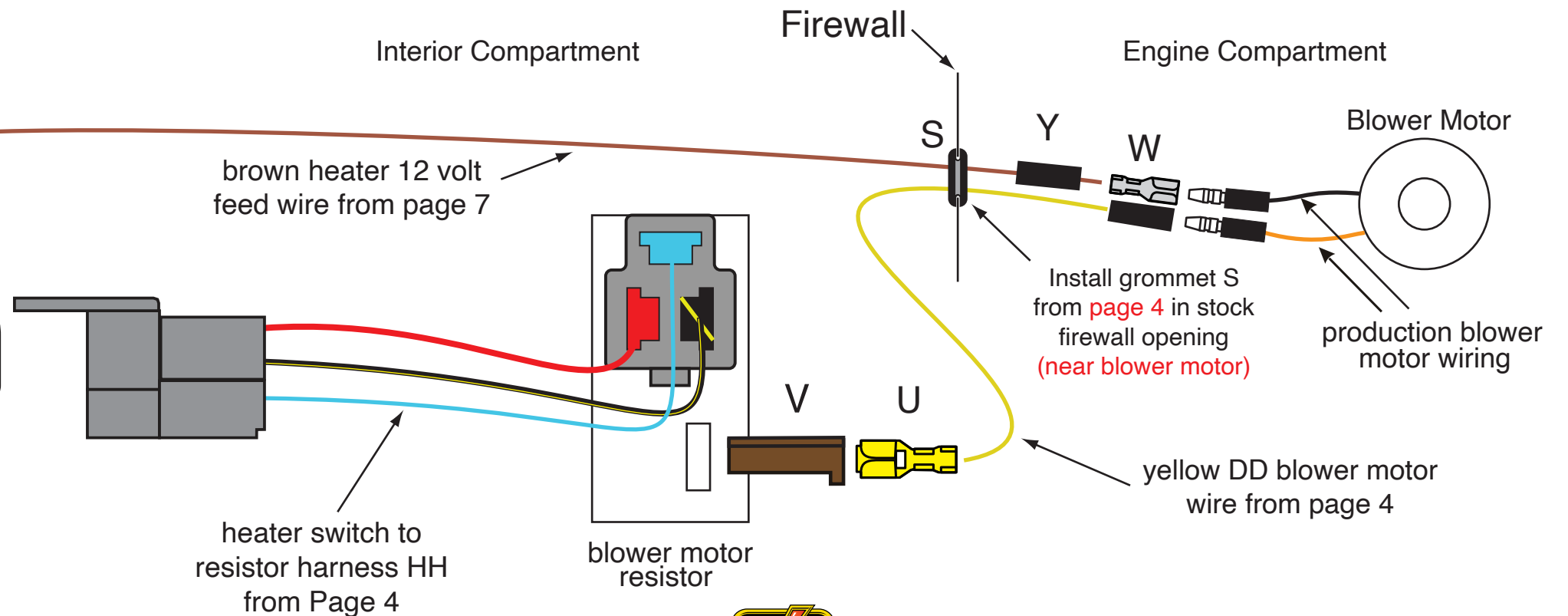







www.americanautowire.com 856-933-0801

1967-68 Mustang
Classic Update Series

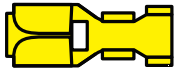
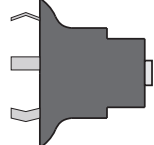
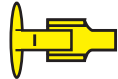
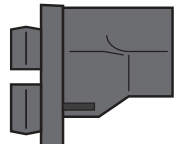
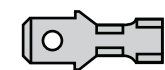
510055 92972103 Rev 2.2 7/8/2022

Gauge Cluster harness installation instructions:

Shown below, are the supplied misc. terminals, plastic connector bodies, light sockets and hardware that will be used to complete your Gauge Cluster harness connections. They are itemized and referred to on this page, just as they are on the following pages of this Gauge Cluster instruction set.

- | | |
|---|--|
| <p>A  (58 series single female conn, 1 pc.)</p> | <p>G  (58 series double female terminal, 2 pcs.)</p> |
| <p>B  (light socket, 10 pcs.)</p> | <p>H  (terminal rivet, 15 pcs.)</p> |
| <p>C  (plastic light socket, 2 pcs.)</p> | <p>J  (.25 male terminal, 2 pcs.)</p> |
| <p>D  (spring, plastic light socket, 3 pcs.)</p> | <p>K  (terminal, plastic light socket ground, 3 pcs.)</p> |
| <p>E  (rubber sleeve, 1 pc.)</p> | <p>L  (shrink tubing, 1 pc.)</p> |
| <p>F  (splice clip, 3 pcs.)</p> | |



**American
Autowire**

www.americanautowire.com 856-933-0801

1967-68 Mustang

Classic Update Series

510055 92972103 Rev 2.2 7/8/2022

How to install light sockets and light socket terminals.

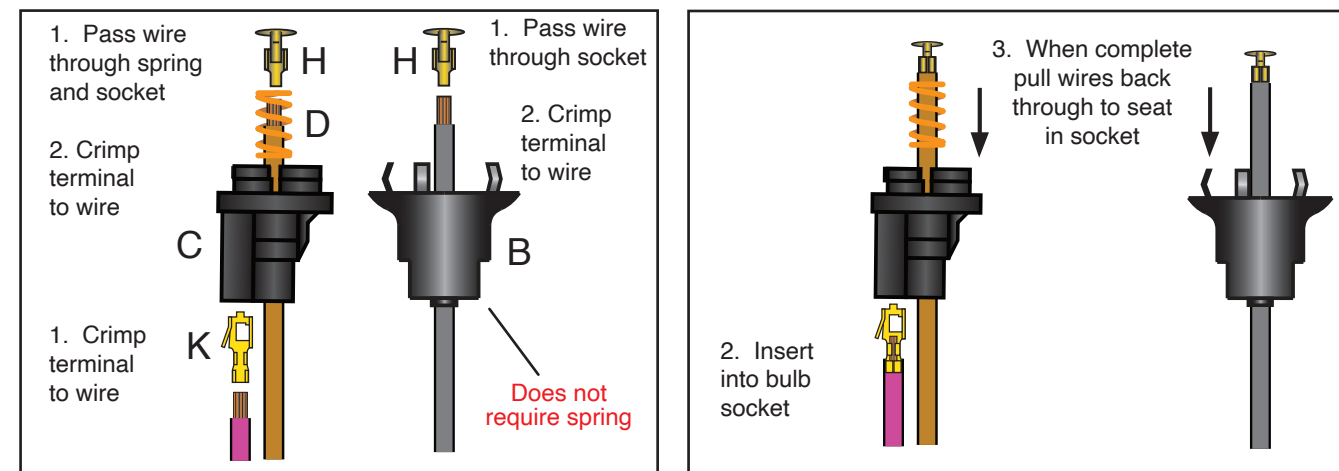

How to use the splice clip to join multiple wires.

Below is just an **EXAMPLE** of how to use the splice clip and shrink tubing; see your specific application on the following pages for actual splice information.

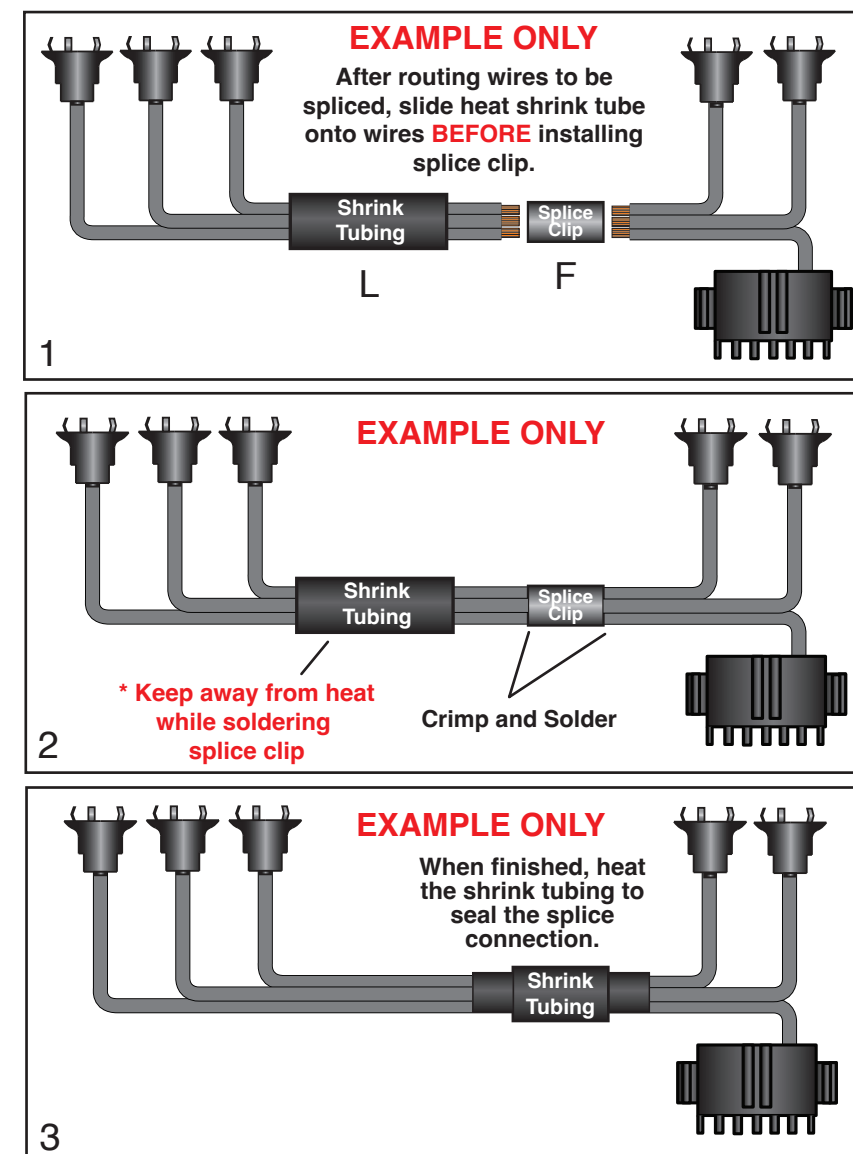

Gauge Cluster harness (aftermarket gauges) installation instructions:

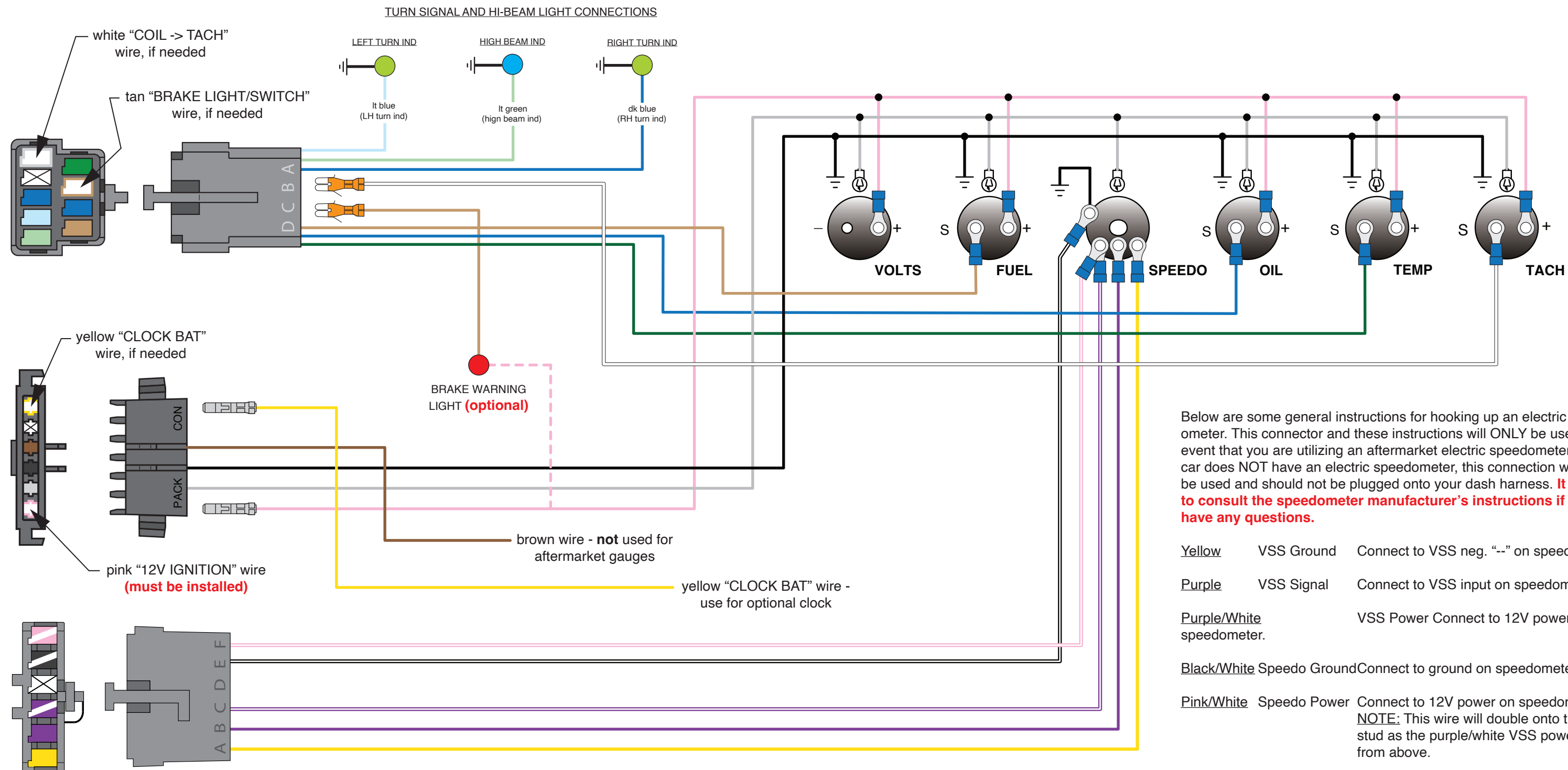

See pages 13-15 for stock dash cluster applications



Gauge Cluster harness installation instructions:

1967-68 Mustang - with Tachometer

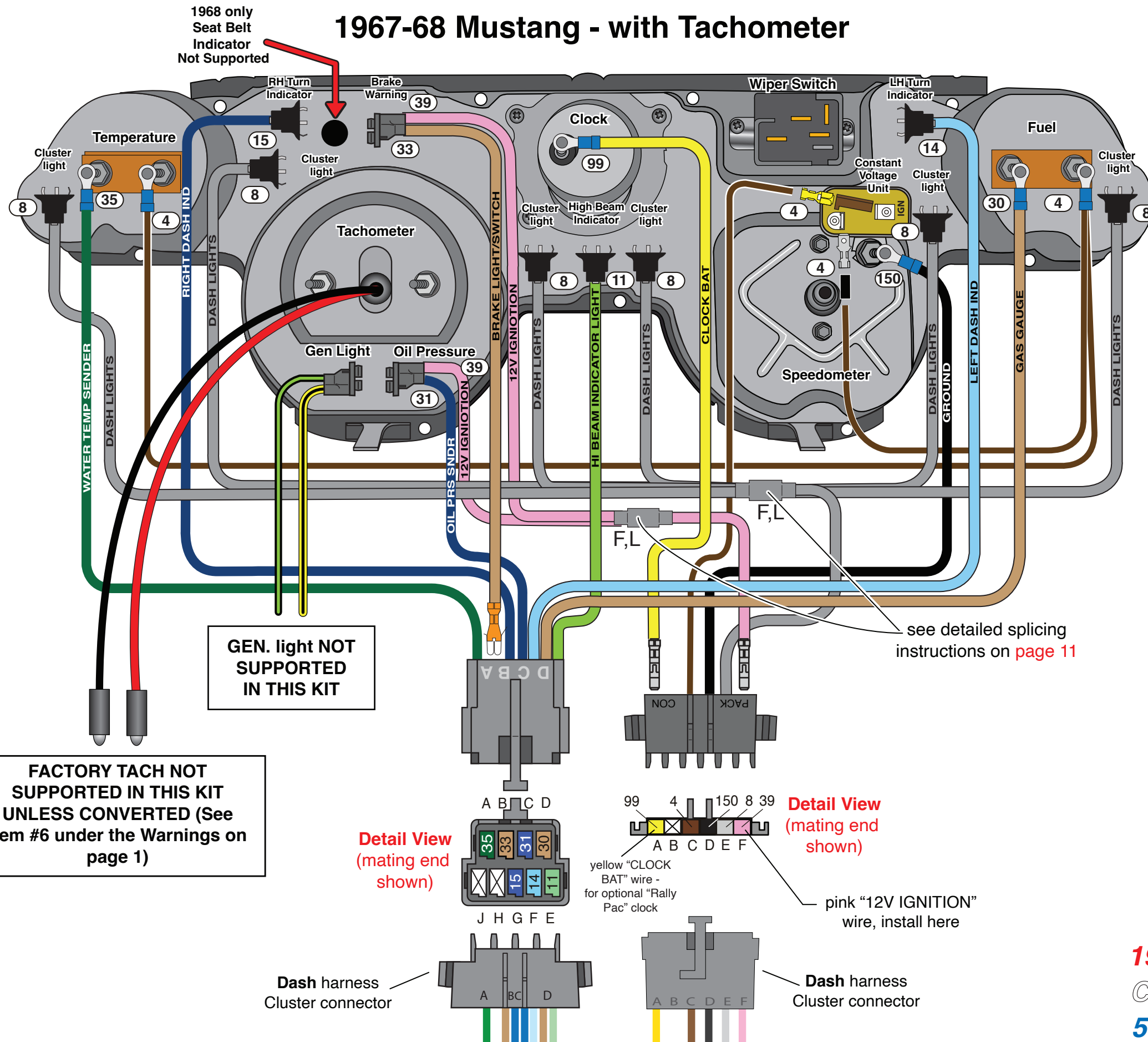

For proper wire locations, refer to "Detail View"

GEN. light NOT SUPPORTED IN THIS KIT

FACTORY TACH NOT SUPPORTED IN THIS KIT UNLESS CONVERTED (See item #6 under the Warnings on page 1)

Detail View (mating end shown)

Detail View (mating end shown)

pink "12V IGNITION" wire, install here

yellow "CLOCK BAT" wire - for optional "Rally Pac" clock

Dash harness Cluster connector

Dash harness Cluster connector



www.americanautowire.com 856-933-0801

1967-68 Mustang
Classic Update Series
510055 92972103 Rev 2.2 7/8/2022

Gauge Cluster harness installation instructions:

1967 Mustang - w/o Tachometer

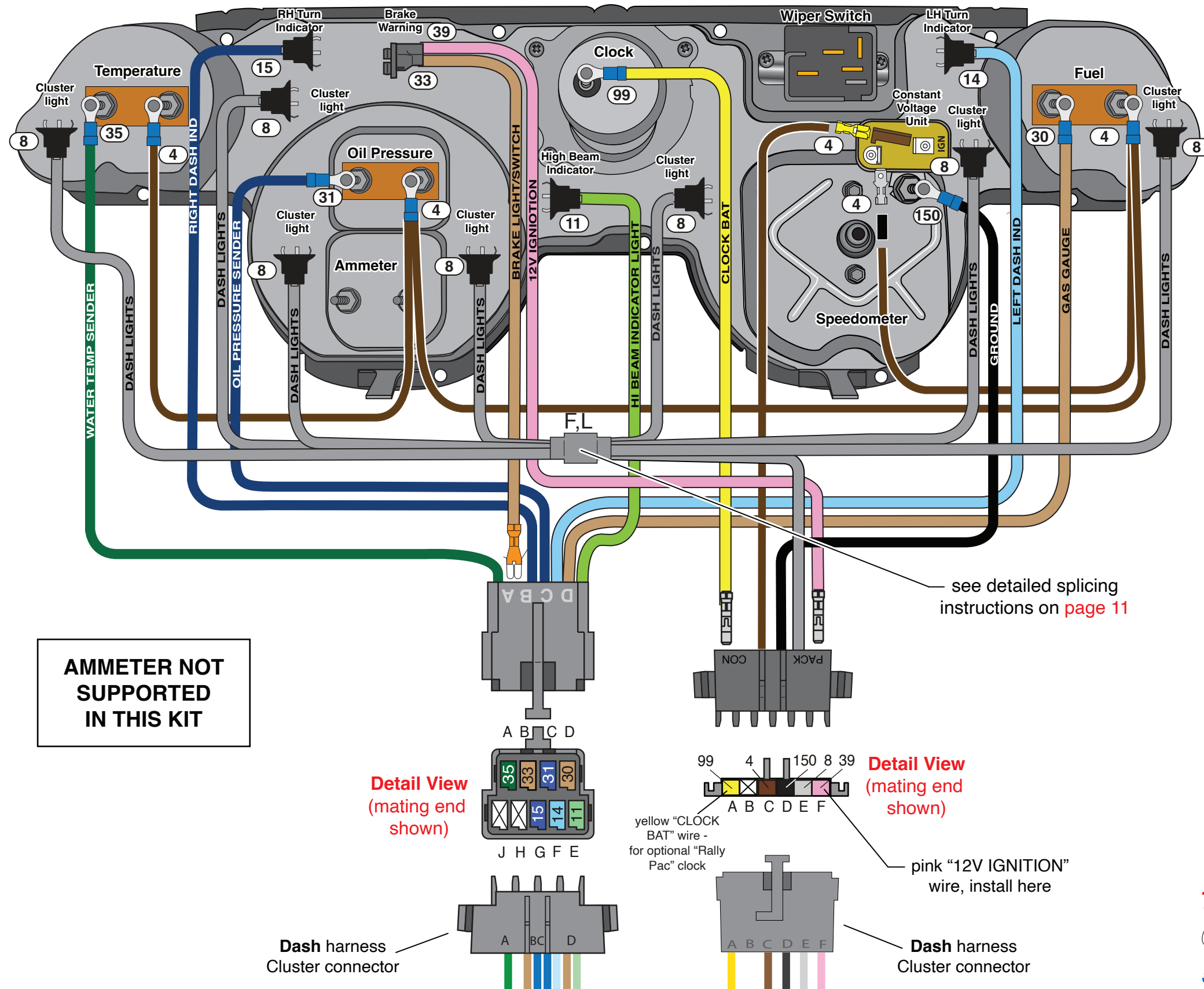

AMMETER NOT SUPPORTED IN THIS KIT

For proper wire locations, refer to "Detail View"

see detailed splicing instructions on page 11

Detail View (mating end shown)

Detail View (mating end shown)

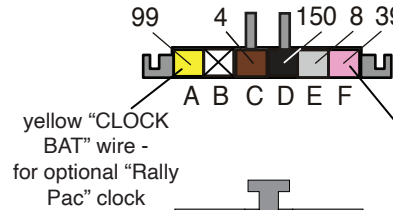

pink "12V IGNITION" wire, install here

Dash harness Cluster connector

Dash harness Cluster connector







www.americanautowire.com 856-933-0801

1967-68 Mustang
Classic Update Series

510055 92972103 Rev 2.2 7/8/2022

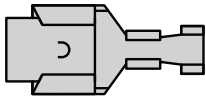
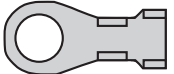
Engine harness installation instructions:

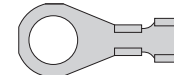
Shown below, are the supplied misc. terminals, sleeves, plastic connector bodies and wires included in the 510466 Engine Harness and Loose Piece bag that will be used to complete your Engine harness connections. They are itemized and referred to on this page, just as they are on the following pages of these Engine installation instructions.

- A  (56 Series single female connector, 2 pcs)
- B  (56 Series single female terminal, 4 pcs)
- C  (ring terminal, 3 pcs)
- D  (large rubber sleeve, 2 pcs)
- E  (ring terminal, 4 pcs)
- F  (small rubber sleeve, 2 pcs)

Engine harness Connections:

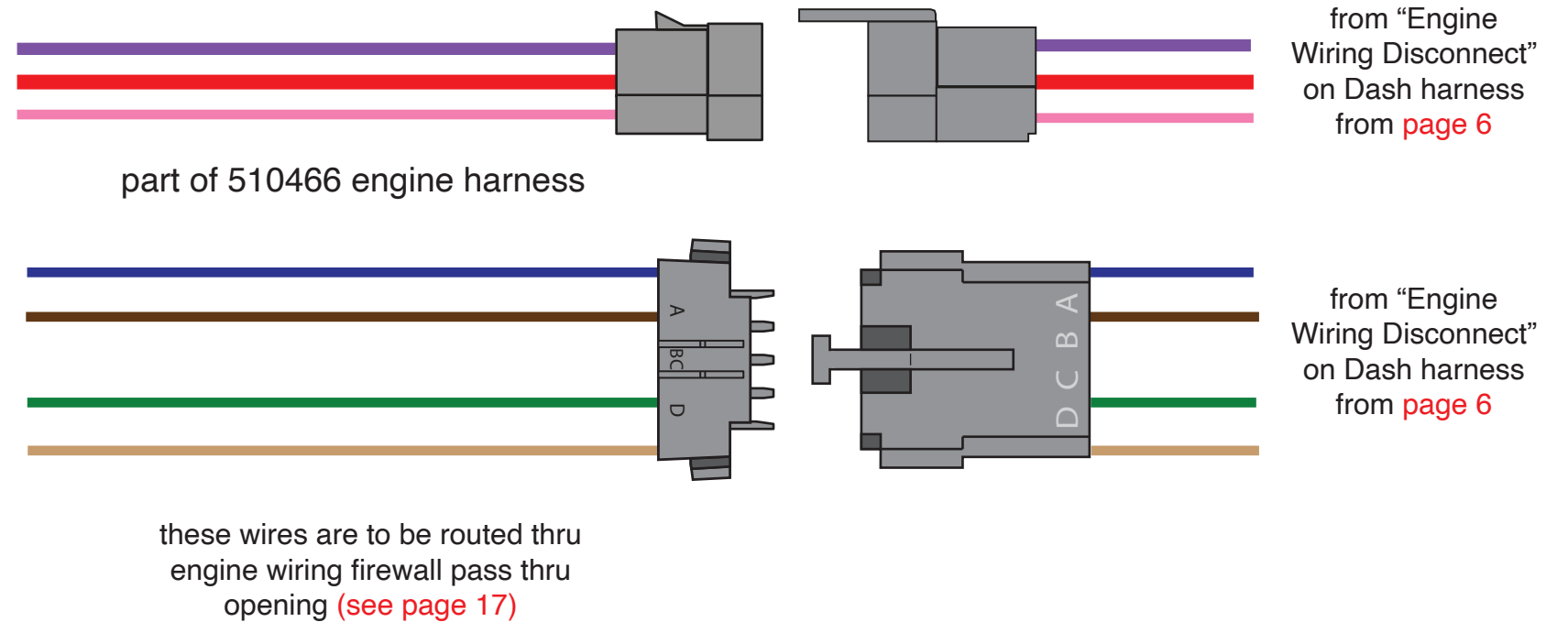

Vehicle Speed Sensor and Tach wiring:

route these wires (along with the other Engine harness wires) thru the engine wiring, firewall pass thru opening (see page 17)

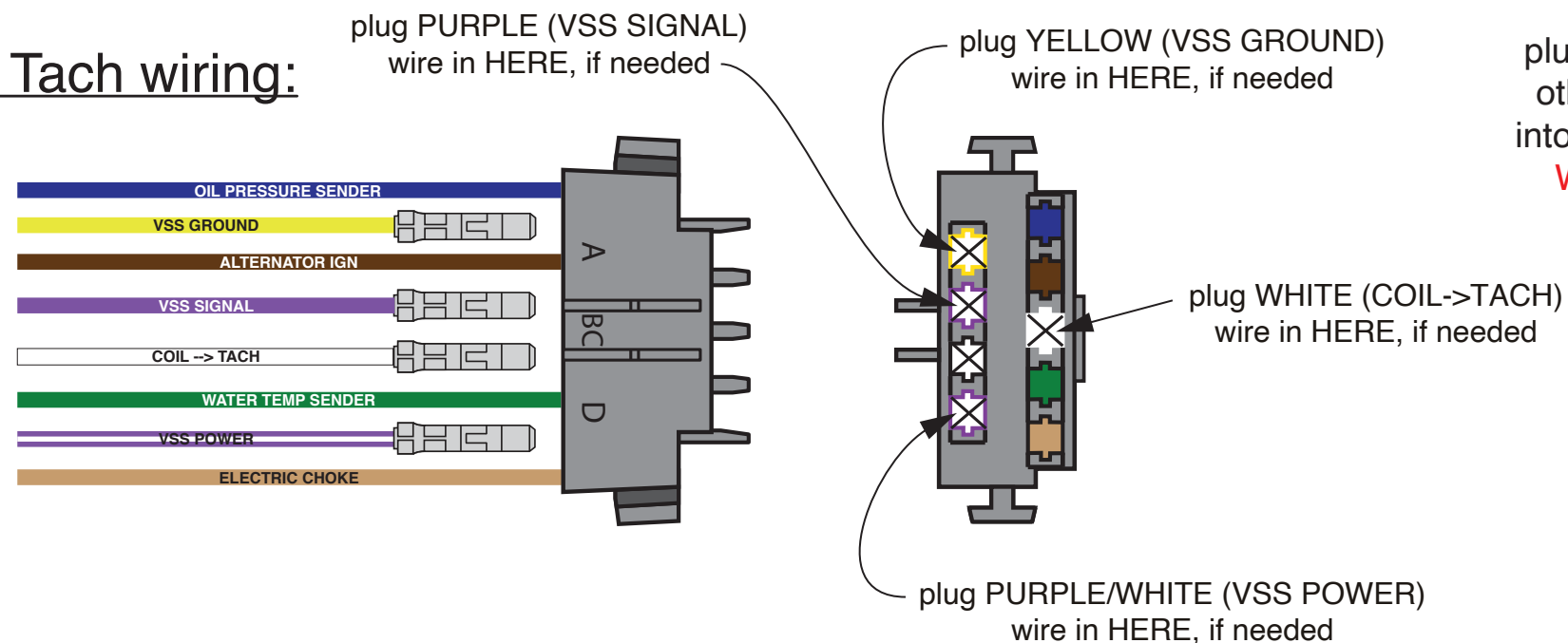

plug this connector (along with the other Engine harness connector) into the Dash harness (see "Engine Wiring Disconnect" on page 6)



www.americanautowire.com 856-933-0801

1967-68 Mustang
 Classic Update Series
510055 92972103 Rev 2.2 7/8/2022

Engine harness installation instructions:

NOTE: yellow VSS ground and solid purple VSS power wires must be twisted together their **entire** length.

Install grommet (see item "T" on page 4 of Dash harness loose piece kit) into the firewall pass thru opening, plug the engine harness (510466) onto the the dash harness inside the car, then pass the engine wiring out thru the grommet and into the engine bay as shown.

1967-68 Mustang
Classic Update Series
510055 92972103 Rev 2.2 7/8/2022



www.americanautowire.com 856-933-0801

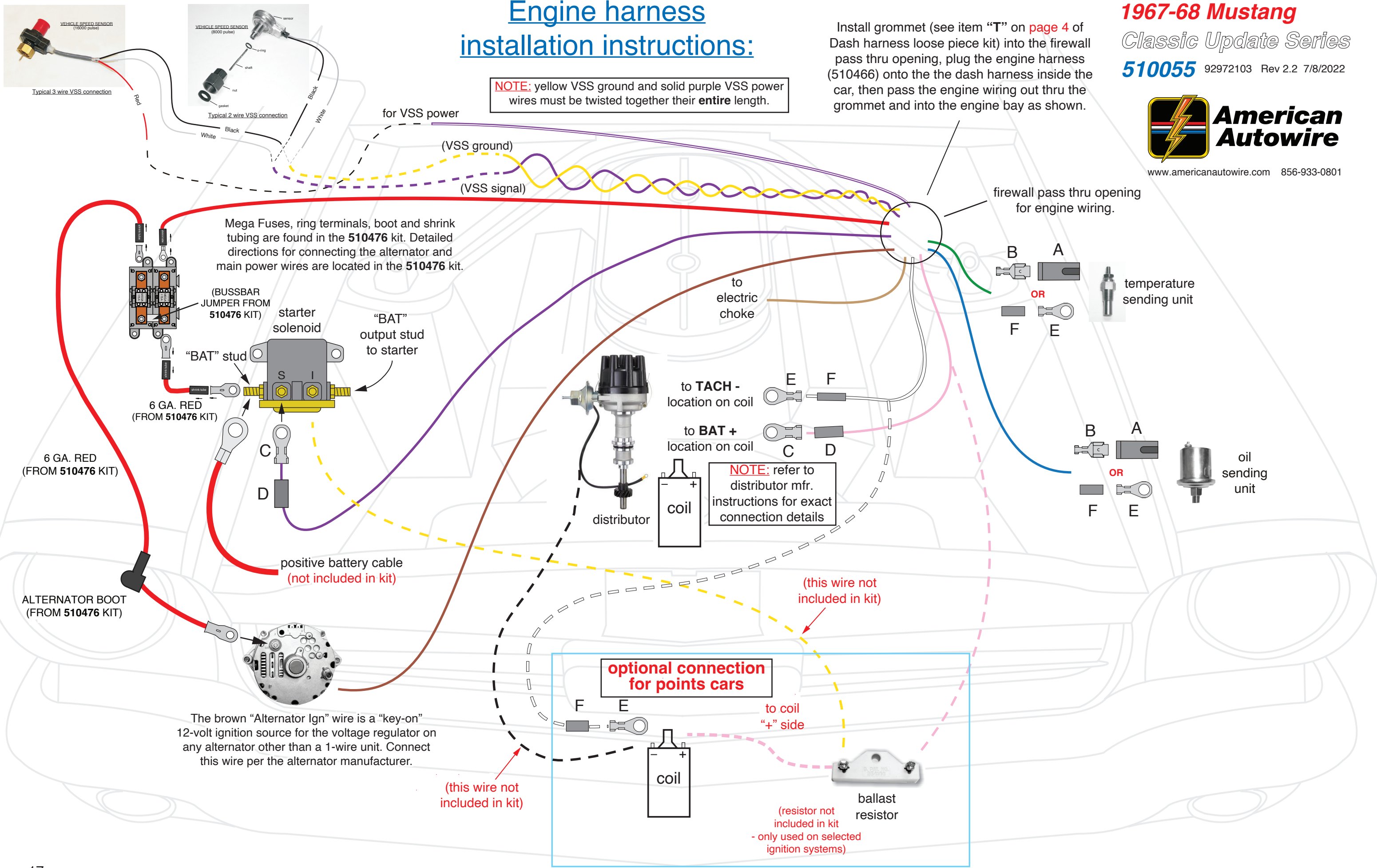

Mega Fuses, ring terminals, boot and shrink tubing are found in the 510476 kit. Detailed directions for connecting the alternator and main power wires are located in the 510476 kit.

(BUSBAR JUMPER FROM 510476 KIT)
starter solenoid
"BAT" stud
"BAT" output stud to starter
6 GA. RED (FROM 510476 KIT)

distributor
coil
to TACH - location on coil
to BAT + location on coil
NOTE: refer to distributor mfr. instructions for exact connection details

optional connection for points cars
to coil "+" side
ballast resistor
(resistor not included in kit - only used on selected ignition systems)

The brown "Alternator Ign" wire is a "key-on" 12-volt ignition source for the voltage regulator on any alternator other than a 1-wire unit. Connect this wire per the alternator manufacturer.

(this wire not included in kit)

(this wire not included in kit)







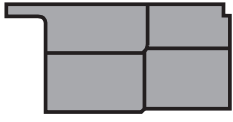

firewall pass thru opening for engine wiring.

temperature sending unit
OR

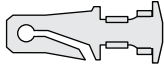
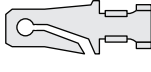
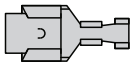
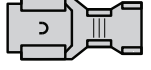
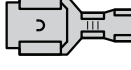
oil sending unit
OR

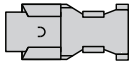
Front Light harness installation instructions:

Shown below, are the supplied misc. terminals, plastic connector bodies, and pigtails included in the 510465 Front Light Harness and Loose Piece bag that will be used to complete your Front Light harness connections. They are itemized and referred to on this page, just as they are on the following pages of these Front Light installation instructions.

- A  (56 Series double female connector, 2 pcs)
- B  (56 Series double male connector, 2 pcs)
- C  (56 Series single female connector, 2 pcs)
- D  (56 Series single male terminal, 5 pcs)
- E  (56 Series double male terminal, 3 pcs)
- F  (56 Series single female terminal, 7 pcs)
- G  (59 Series double female terminal, 4 pcs)
- H  (59 Series single female terminal, 4 pcs)
- J  (56 Series single female connector, 1 pc)
- K  (56 Series double female terminal, 2 pcs)
- L  (Brake pressure differential warning switch, 1 pc)
- M  (67-68 hood mounted directional lights pigtail, 1 pc)
- N  (headlight connector assy, 2 pcs)

Front light harness (and 1967-68 hood mounted directional light wiring only):

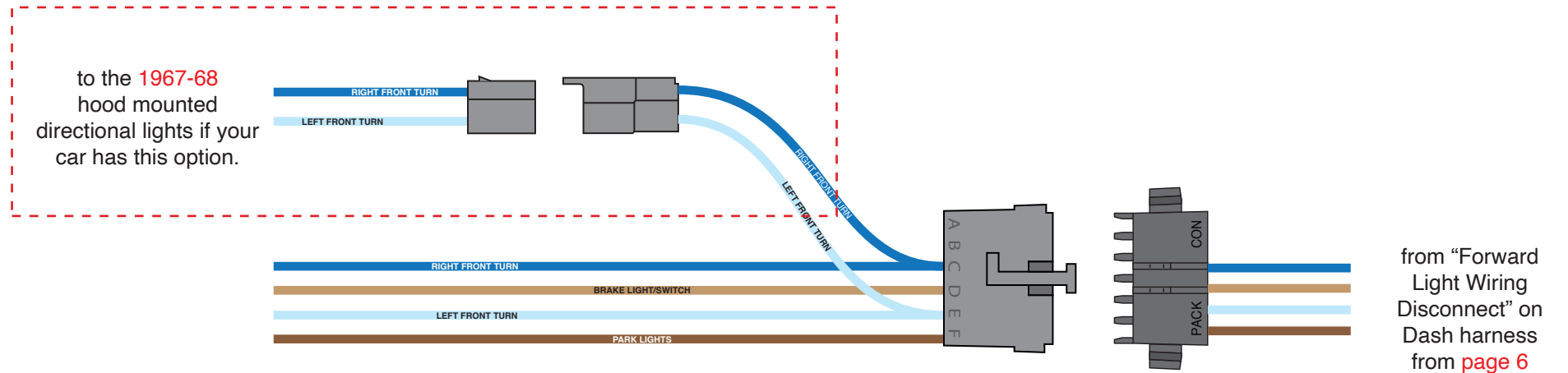

part of 510465 front light harness

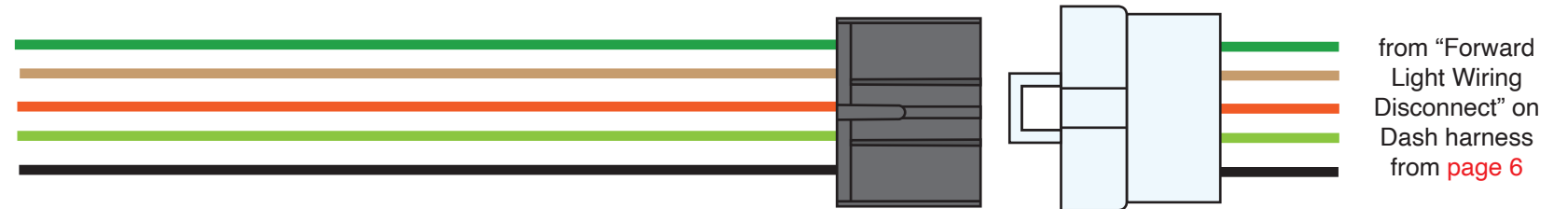

these wires are to be routed thru forward lamp wiring firewall pass thru opening (see page 19)



www.americanautowire.com 856-933-0801

1967-68 Mustang
 Classic Update Series
510055 92972103 Rev 2.2 7/8/2022

Front Light harness installation instructions:



www.americanautowire.com 856-933-0801

1967-68 Mustang
 Classic Update Series
510055 92972103 Rev 2.2 7/8/2022

Previously installed grommet (see page 17 of this instruction set) from the engine harness installation instructions. Plug the front light (510465) harness onto the the dash harness inside the car, then pass the front light wiring out thru the grommet and into the engine bay as shown. After all of the engine and front light wires are passed thru the grommet out into the engine bay as shown, apply silicone sealer to this area to make a weather-tight seal.

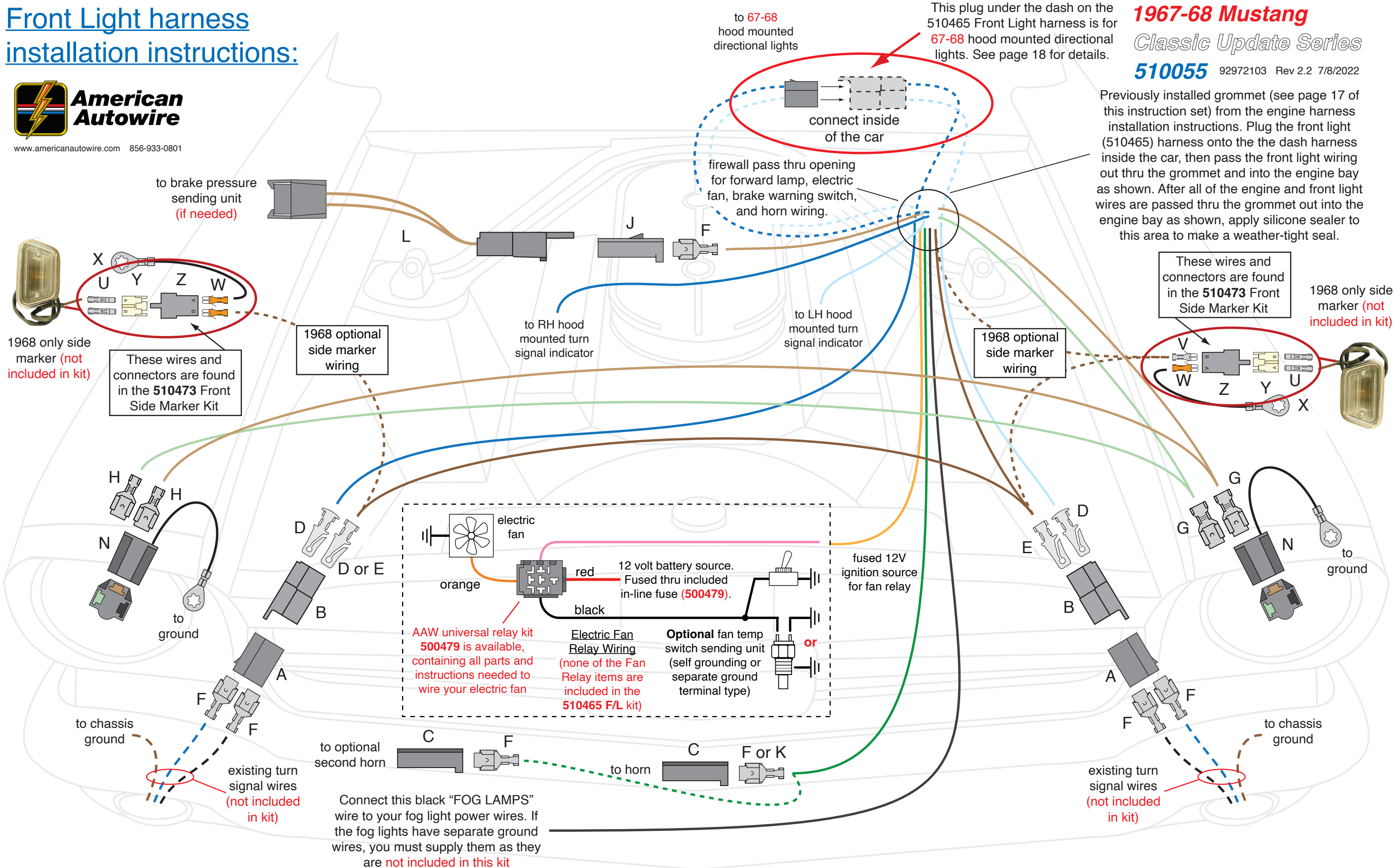

Rear Body harness installation instructions:

Shown below, are the supplied misc. terminals, plastic connector bodies, clamps and wire extensions included in the 510462 Rear Body Harness and Loose Piece bags that will be used to complete your Rear Body harness connections. They are itemized and referred to on this page, just as they are on the following pages of these Rear Body installation instructions.

A  (56 Series single female terminal, 10 pcs)

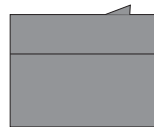
B  (56 Series double female connector, 4 pcs)

C  (56 Series double male connector, 2 pcs)

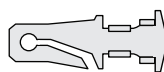
D  (56 Series single male terminal, 6 pcs)

E  (56 Series single male terminal, 5 pcs)

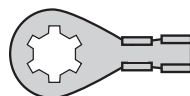
F  (ring terminal, 5 pcs)

G  (single female terminal, 5 pcs)

H  (large rubber sleeve, 5 pcs)

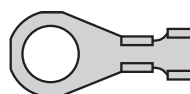
J  (ring terminal, 2 pcs)

K  (male bullet terminal, 3 pcs)

L  (small rubber sleeve, pcs)

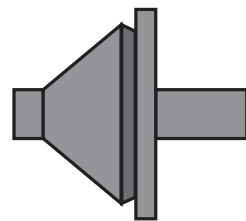
M  (rubber grommet, 1 pc)

N  (56 Series double female terminal, 2 pcs)

O  (12V CTSY SW wire, 1 pc)

P  (12V CTSY SW wire, 1 pc)

Q  (THIRD BRAKE LIGHT wire, 1 pc)

R  (12V BATTERY-FUSED wire, 1 pc)

S  (CTS Y GROUND wire, 2 pcs)

T  (backup light pigtail, 2 pcs)

U  (LH tail lamp pigtail, 1 pc)

V  (RH tail lamp pigtail, 1 pc)



www.americanautowire.com 856-933-0801

1967-68 Mustang
Classic Update Series
510055 92972103 Rev 2.2 7/8/2022

Rear Body harness installation instructions:

1967-68 Mustang
 Classic Update Series
510055 92972103 Rev 2.2 7/8/2022

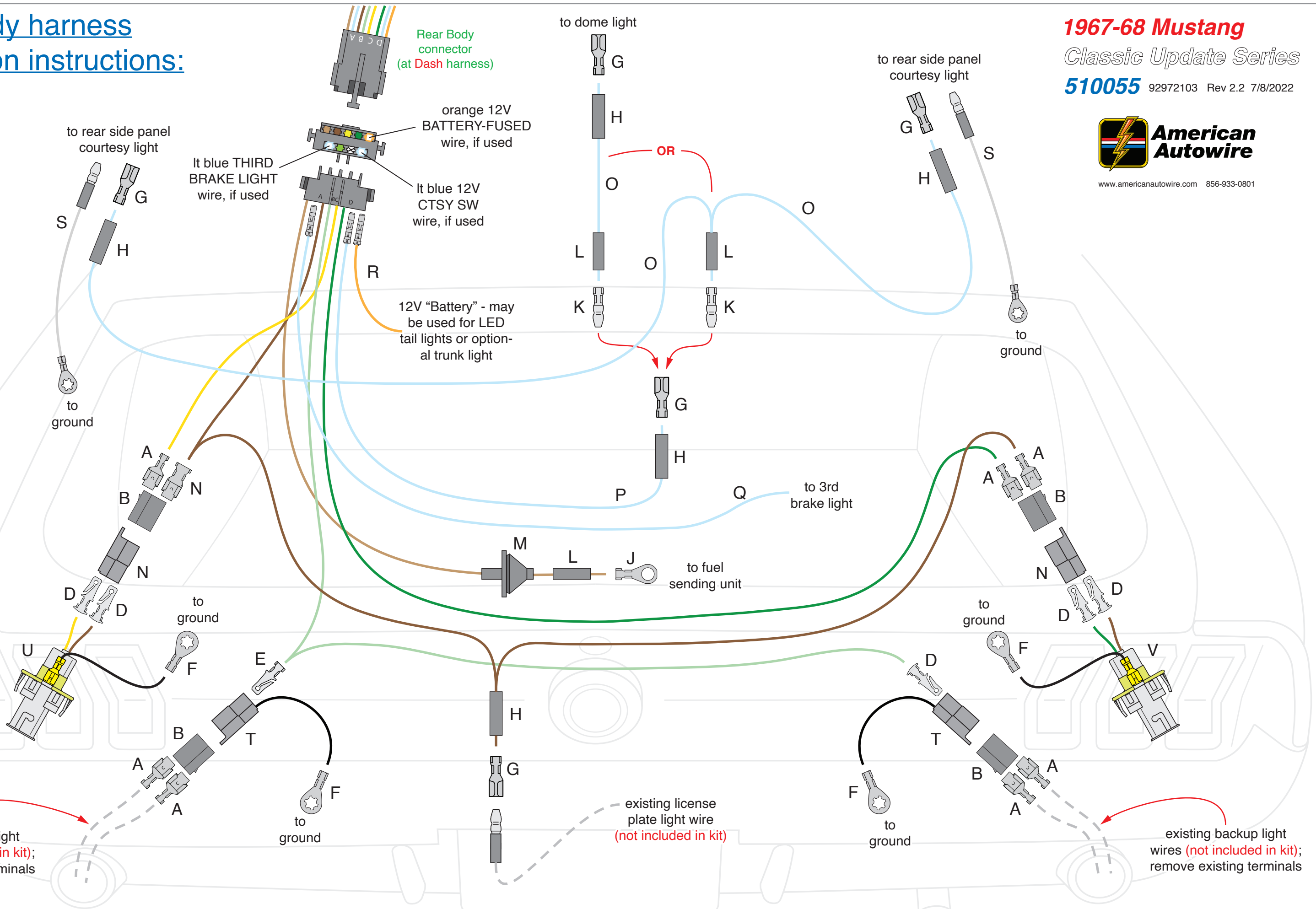

Washer/Wiper switch wiring:

510131 wiper and washer harness

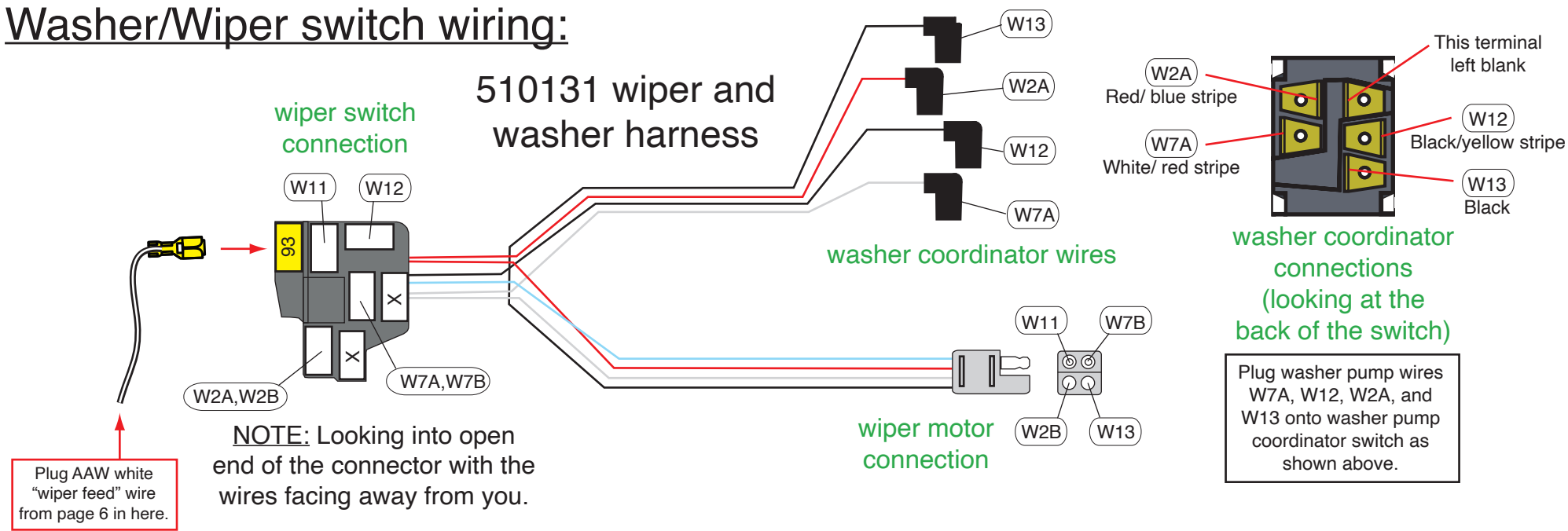

WIPER HARNESS DETAILS:

NOTE 1: All 1967 - 68 2 speed wiper with washer applications use the set up shown at the left. The white "wiper feed" wire (93) from your dash harness (as found on page 6) will plug into the new 510131 wiper / washer harness included with your kit as shown. The finished wiper switch connection will plug onto your dash mounted wiper switch (not included with this kit). The wiper motor connection will plug onto your wiper motor assembly with no modifications needed. The washer pump connections are numbered and noted at left. They must be plugged onto the back of the foot operated coordinator switch as noted at left or your motor WILL NOT operate properly. If you do not have the washer pump in your car any longer, see **NOTE 2** below.

NOTE 2: If you no longer have your coordinator assembly in place, you must connect the black/yellow (circuit W12) and the black (circuit W13) wires at the washer coordinator together to bring the full functionality back to the wiper system. With these two wires connected together, and the other two washer coordinator wires (red/blue and white/red) not connected, you will regain the full function of your wiper motor including Low Speed, High Speed, and Park (the dynamic brake function is now functional again).

Fuse Label, Values and Locations

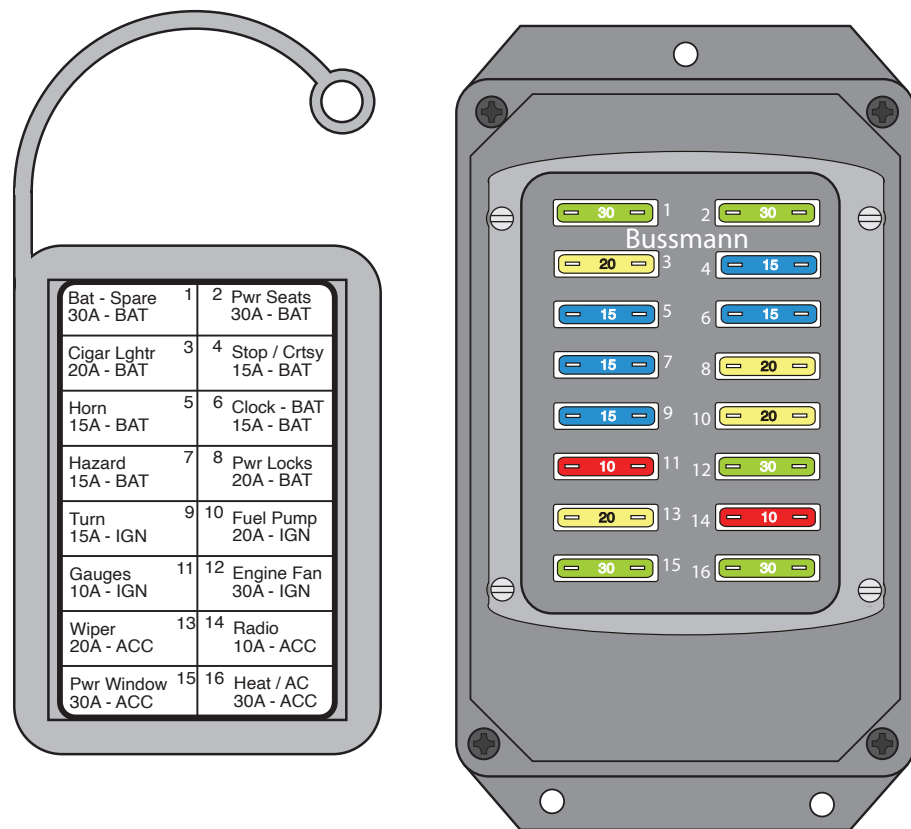

Fuse/Circuit table

Fuse #	Fuse Block Cover Label	Fuse Rating	Description
1	Bat-Spare	30A	Battery feed for Headlight relays.
2	Pwr Seats	30A	Battery feed for optional Power Seats.
3	Cigar Lghtr	20A	Battery feed for the Cigarette Lighter.
4	Stop / Crtsy	15A	Battery feed for Brake Lights, Dash Lights, Courtesy and Dome Lights, to Rear Body Harness for options and the Glove Box Light.
5	Horn	15A	Battery feed to Horn relay.
6	Clock - Bat	15A	Battery feed for a Clock and a Radio.
7	Hazard	15A	Battery feed for optional Hazard Lights and optional battery feed.
8	Pwr Locks	20A	Battery feed for optional Power Locks.
9	Turn	15A	Ignition feed for the Turn Signals.
10	Fuel Pump	20A	Ignition feed for an Electric Fuel Pump and optional Electronic Speedometer System.
11	Gauges	10A	Ignition feed for an Electric Choke, Dash Gauges/Warning Lights and Back-up Lights.
12	Engine Fan	30A	Ignition feed for an optional Electric Fan System.
13	Wiper	20A	12V Accessory feed for Wiper/Washer system.
14	Radio	10A	12V Accessory "on-off" feed to Radio.
15	Pwr Window	30A	12V Accessory feed for optional Power Windows.
16	Heat / AC	30A	12V Accessory feed for Heater/AC System.

STEP 3: RECONNECT YOUR BATTERY:

When you have completed the installation and are ready to reconnect the battery, make sure that the following electrical system grounds are in place:

- A. Battery is grounded to the ENGINE BLOCK.
- B. Battery is grounded to the frame.
- C. Engine block is grounded to the frame.
- D. Body is grounded to the frame.

STEP 4: CHECK ALL ELECTRICAL FUNCTIONS:

Any non-functioning items should be checked for proper installation. Any problems with your wiring and electrical circuit functions, should be addressed to American Autowire Systems, Inc. as soon as possible, to avoid any warranty problems.

If you have any questions concerning this or any of our products, please feel free to call us at 1-856-933-0801.



**American
Autowire**

1967-68 Mustang
Classic Update Series

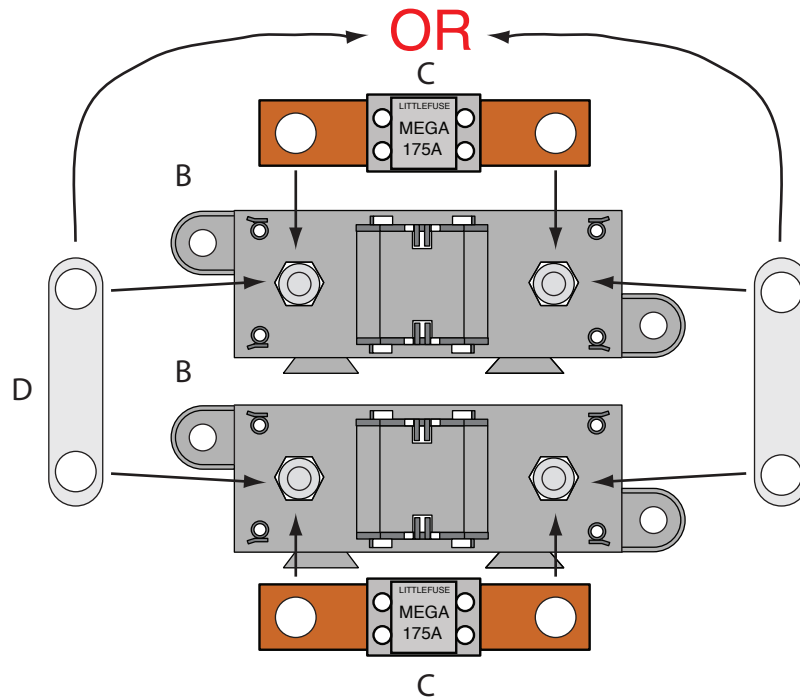

Assembling the (2) Megafuse assemblies

NOTE: Find a suitable place, as close to the battery power source as possible, under the hood of your vehicle to mount the completed Megafuse assemblies. Keep in mind that you have 12 feet of 6Ga. charging wire, and that the main power feed coming from your panel or bulkhead connection must also be able to reach the assembly.

1. Take the two Megafuse bodies and covers (items B) and snap them together. Remove the 4 nuts and lock washers from the studs on the fuse body assemblies.
2. Install the Megafuse jumper (item D above) over two of the studs on the Megafuse bodies. It is very important that the jumper **MUST BE** assembled on the side that is going to connect to your main power connection (starter solenoid or battery feed).
3. Notch top cover to clear jumper D as shown at right.
4. Snap one 175amp fuse (items C) onto the studs of each of the two Megafuse bodies (items B), over the jumper, then loosely re-attach the 4 nuts and lock washers back onto the assembled Megafuses. The fuse assemblies are ready to install into your vehicle.

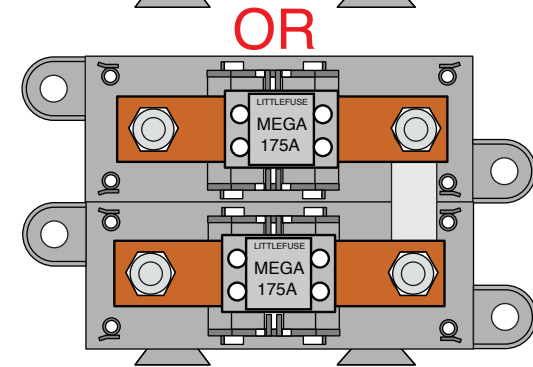
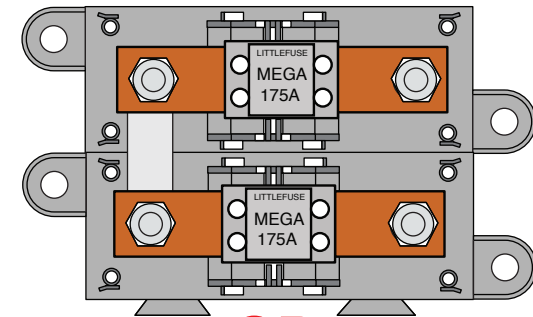

Assembled Megafuses

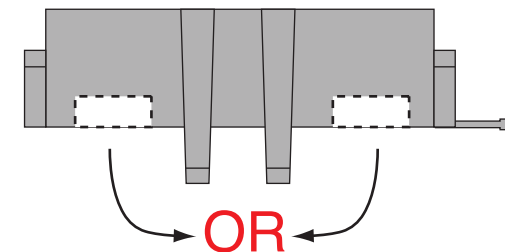

Notched Cover

PART #

510476

Z

DESCRIPTION:

Alternator and Main Power
Connection Kit
Various Applications

92972153 instruction sheet rev 0.1 6/24/2019

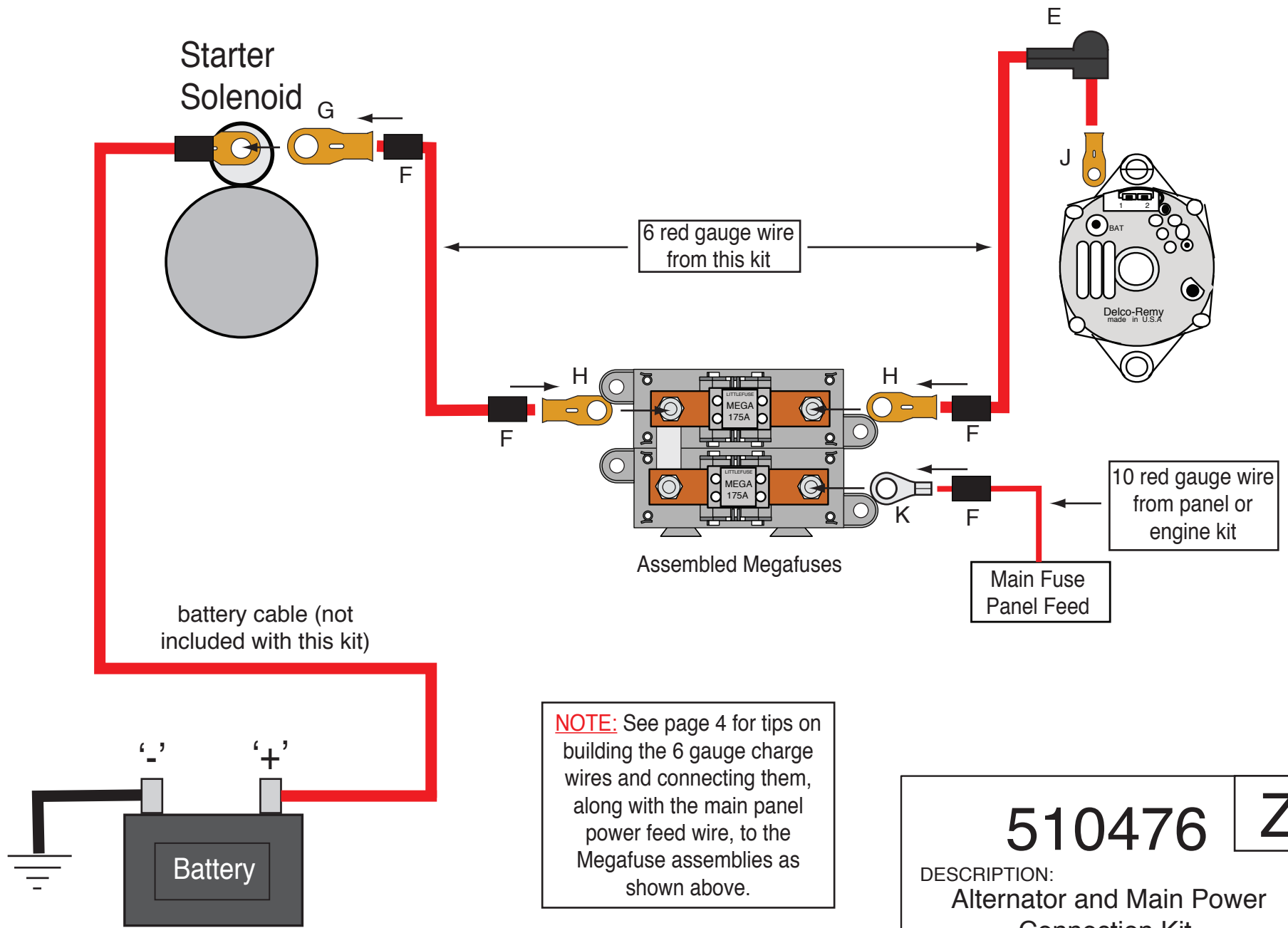

NOTE: See page 4 for tips on building the 6 gauge charge wires and connecting them, along with the main panel power feed wire, to the Megafuse assemblies as shown above.

<h1 style="margin: 0;">510476</h1>	Z
<p>DESCRIPTION: Alternator and Main Power Connection Kit Various Applications</p>	
<p>92972153 instruction sheet rev 0.1 6/24/2019</p>	

Building the 6Ga. charge wires and connecting them and the main panel power feed wire to the Megafuse assemblies:

NOTE: Make sure that your battery is disconnected! You will need to install the preassembled Megafuses from page 2 in your vehicle to start this part of the installation.

1. Pre-cut item F shrink tubing into (6) 1.00" - 1.25" pieces.
2. Take the 12-foot piece of 6Ga. red wire from this kit and route it from your starter (or other battery feed) over to the area where you have mounted your Megafuse and cut it to length. Strip the insulation on each end back 1/2". Install 2 pieces of shrink tubing F onto the wire. At the starter end, crimp and solder (1) of terminal G onto the wire. At the Megafuse end, crimp and solder (1) of terminal H onto the wire. Slide the shrink tubing over the terminals and heat it up to shrink it down.
3. Take the remaining portion of the 12-foot piece of 6Ga. red wire from this kit and route it from your alternator over to the area where you have mounted your Megafuse and cut it to length. Strip the insulation on each end back 1/2". Install 1 piece of shrink tubing F onto the wire. At the alternator end, slip on boot E as shown on page 3, then crimp and solder (1) of terminal J onto the wire. At the Megafuse end, crimp and solder (1) of terminal H onto the wire. Slide the shrink tubing over terminal H and heat it up to shrink it down.
4. Take the 10Ga. red main power feed wire from your engine or panel sub-kit and route it over to the area where you have mounted your Megafuse and cut it to length. Strip the insulation back 3/8". Install 1 piece of shrink tubing F onto the wire, then crimp and solder (1) of terminal K onto the wire.
5. Remove the 4 loosely tightened nuts and lock washers from the assembled Megafuses, then using the drawing on page 3 as a guide, install your pre-assembled wires from steps 2-4 above. Re-install the 4 nuts and lock washers onto the assembled Megafuses and tighten them down. This part of your installation is now complete.

510476

Z

DESCRIPTION:

**Alternator and Main Power
Connection Kit
Various Applications**

92972153 instruction sheet rev 0.1 6/24/2019

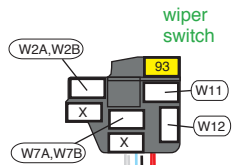

Plug in the white "wiper power feed" wire as shown on the main instruction set 92972103 (pages 6 and 22), to complete the wiper / washer circuit.

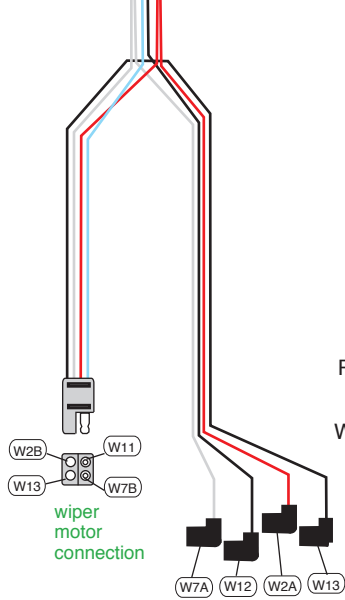

washer pump wires

Plug washer pump wires W7A, W12, W2A, and W13 onto washer pump switch coordinator as shown below.

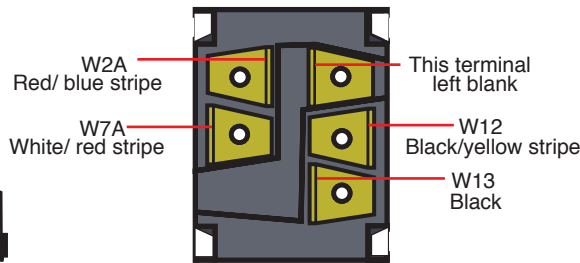

washer pump connections

- W2A Red/ blue stripe
- W2B Red/ blue stripe
- W7A White/ red stripe
- W7B White/ red stripe
- W11 Light blue
- W12 Black/yellow stripe
- W13 Black

- Wiper switch to washer pump connection.
- Wiper switch to wiper motor connection.
- Wiper switch to washer pump connection.
- Wiper switch to wiper motor connection.
- Wiper switch to wiper motor connection.
- Wiper switch to washer pump connection.
- Wiper motor to washer pump connection.

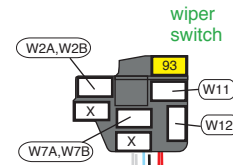

Plug in the white "wiper power feed" wire as shown on the main instruction set 92972103 (pages 6 and 22), to complete the wiper / washer circuit.

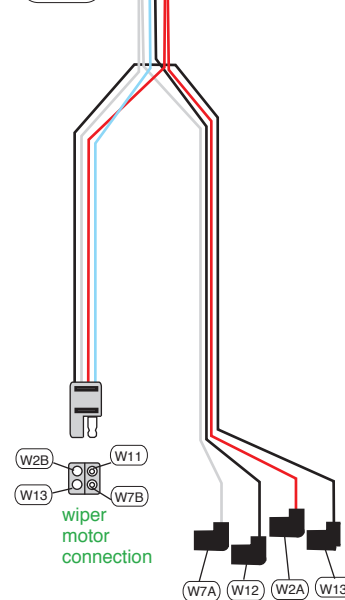

washer pump wires

Plug washer pump wires W7A, W12, W2A, and W13 onto washer pump switch coordinator as shown below.

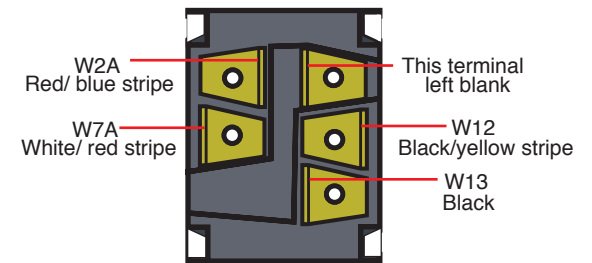

washer pump connections

- W2A Red/ blue stripe
- W2B Red/ blue stripe
- W7A White/ red stripe
- W7B White/ red stripe
- W11 Light blue
- W12 Black/yellow stripe
- W13 Black

- Wiper switch to washer pump connection.
- Wiper switch to wiper motor connection.
- Wiper switch to washer pump connection.
- Wiper switch to wiper motor connection.
- Wiper switch to wiper motor connection.
- Wiper switch to washer pump connection.
- Wiper motor to washer pump connection.



150 Heller Pl #17 W Bellmawr, NJ 08031 856-933-0801

PART #

510131

bag
N

DESCRIPTION:

Washer Wiper Wiring
1967-68 Mustang
Classic Update Series

92969243 instruction sheet rev 4.0 6/25/2018



150 Heller Pl #17 W Bellmawr, NJ 08031 856-933-0801

PART #

510131

bag
N

DESCRIPTION:

Washer Wiper Wiring
1967-68 Mustang
Classic Update Series

92969243 instruction sheet rev 4.0 6/25/2018

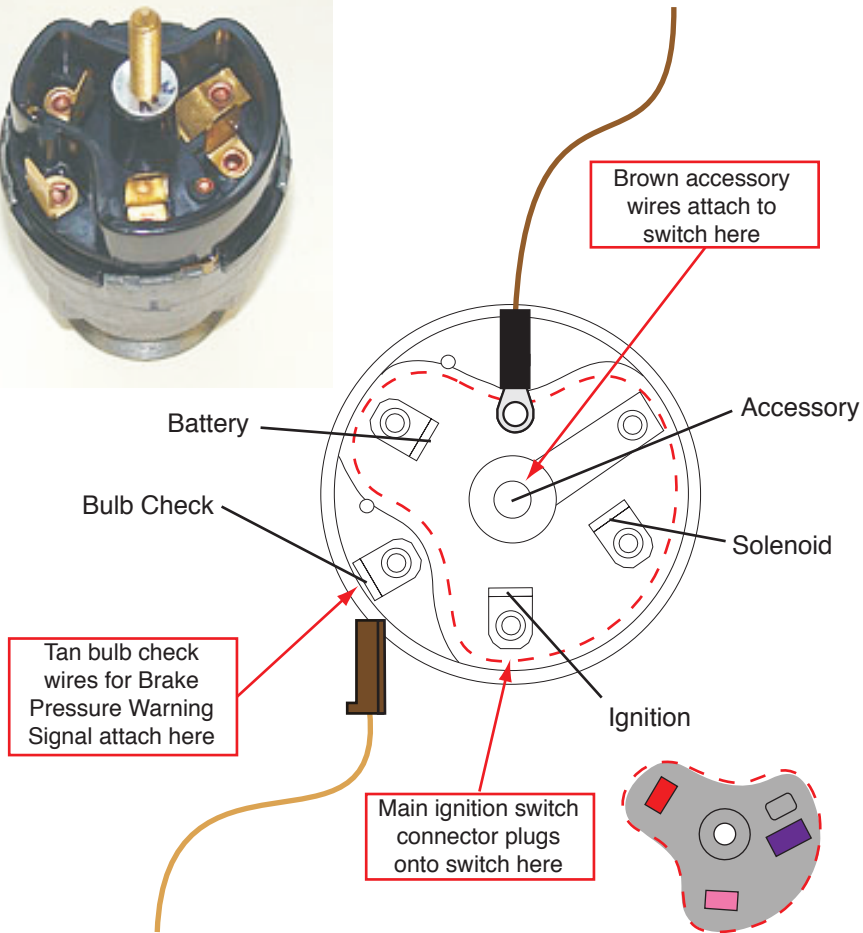

Watch our "Tech Tips" Video to help with your installation.
<http://www.youtube.com/watch?v=2KtpWvDRdFk>

PART #

510053

DESCRIPTION:

Ignition Switch
 Classic Update Series

92968930 instruction sheet rev 4.0 7/16/2018



www.americanautowire.com 856-933-0801

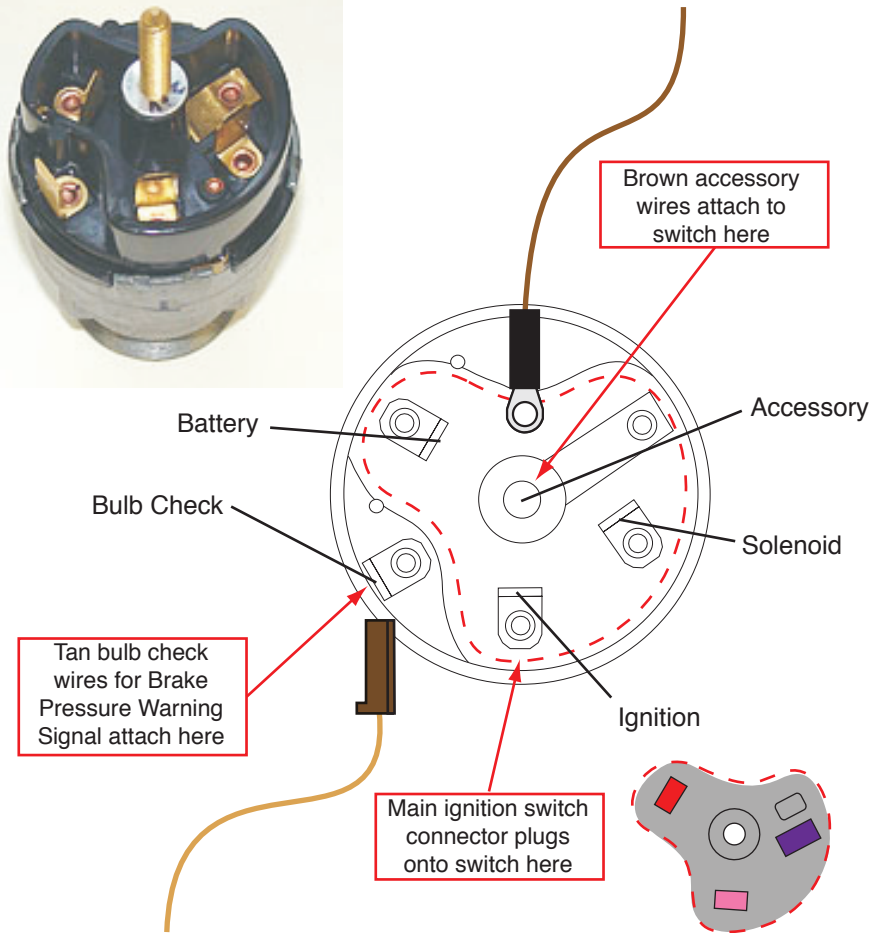

Watch our "Tech Tips" Video to help with your installation.
<http://www.youtube.com/watch?v=2KtpWvDRdFk>

PART #

510053

DESCRIPTION:

Ignition Switch
 Classic Update Series

92968930 instruction sheet rev 4.0 7/16/2018



www.americanautowire.com 856-933-0801

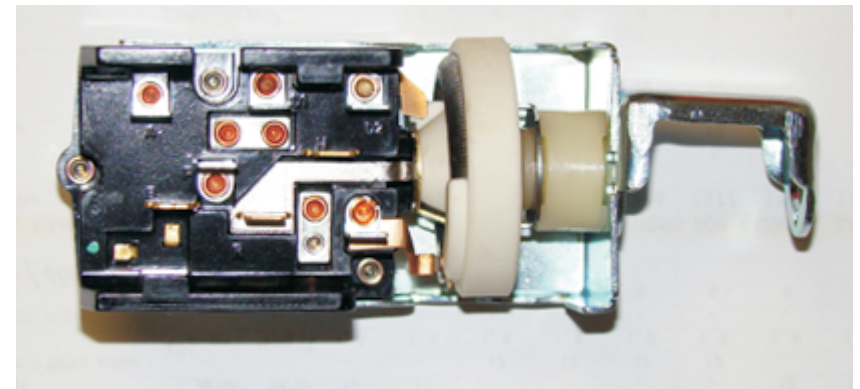
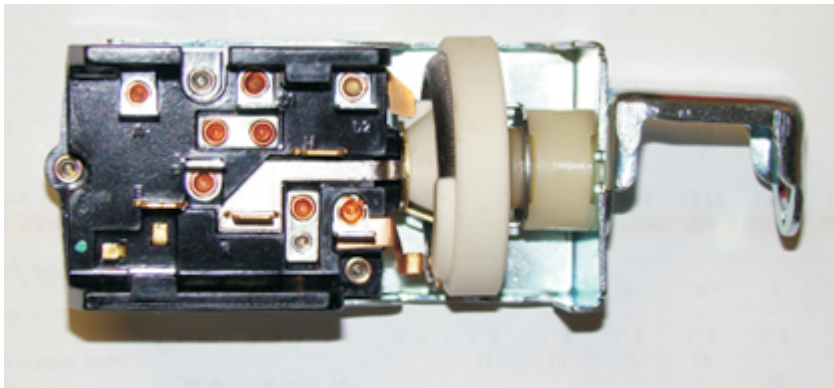
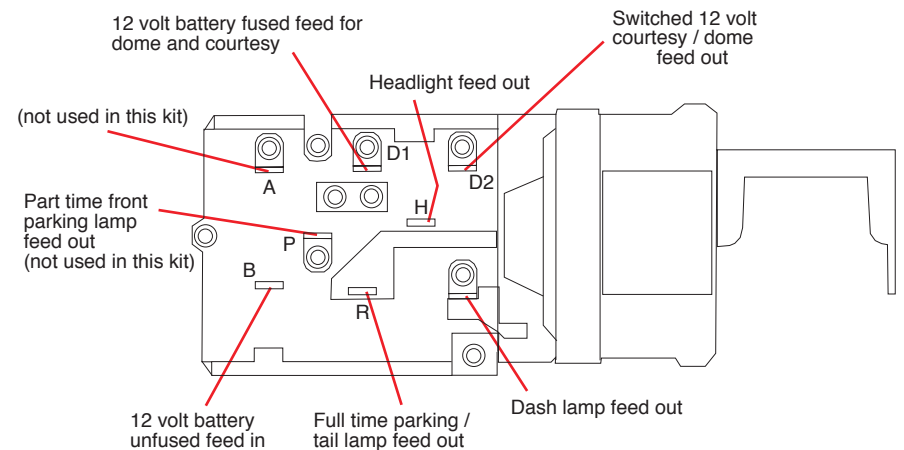
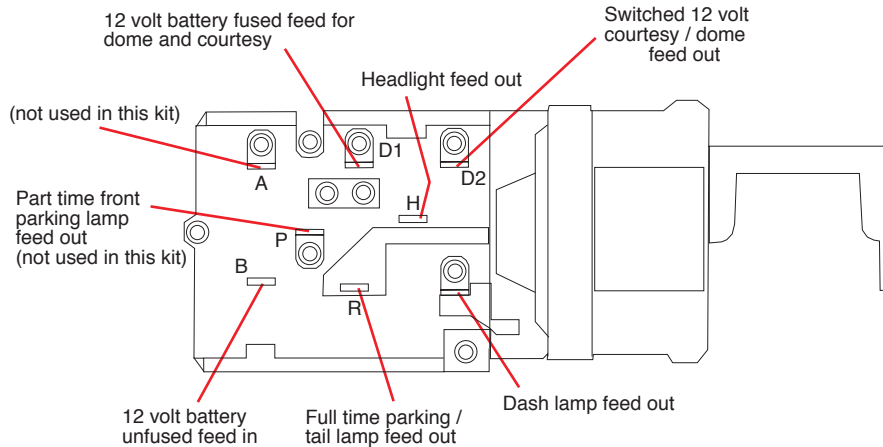

NOTE: Some early production 1964 1/2 Mustangs used a unique headlight switch assembly that utilized a shorter knob and shaft assembly than the later production 65 - 66 Mustang and 1965 Falcons used (3.63" vs. 3.90"). Your new AAW switch needs the later production style knob and shaft in order to operate. If you are using this switch on an early production 1964 1/2 Mustang, you will need to purchase the newer long style knob and shaft assembly from your favorite Mustang parts supplier as your original will be too short to operate this new switch.

NOTE: Some early production 1964 1/2 Mustangs used a unique headlight switch assembly that utilized a shorter knob and shaft assembly than the later production 65 - 66 Mustang and 1965 Falcons used (3.63" vs. 3.90"). Your new AAW switch needs the later production style knob and shaft in order to operate. If you are using this switch on an early production 1964 1/2 Mustang, you will need to purchase the newer long style knob and shaft assembly from your favorite Mustang parts supplier as your original will be too short to operate this new switch.



www.americanautowire.com 856-933-0801

PART #

510054

DESCRIPTION:

Headlight Switch
Various Ford Models
Classic Update Series

92968933 instruction sheet rev 3.0 2/12/2014



www.americanautowire.com 856-933-0801

PART #

510054

DESCRIPTION:

Headlight Switch
Various Ford Models
Classic Update Series

92968933 instruction sheet rev 3.0 2/12/2014

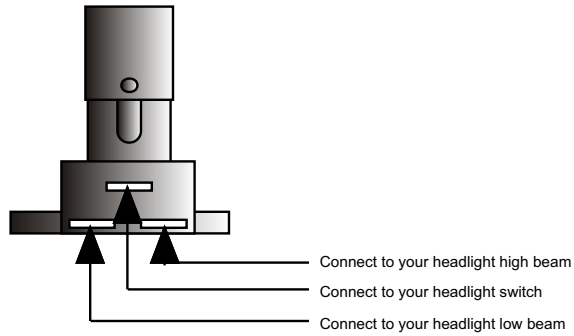

Connect the Dimmer Switch wires as shown above.

1. The top center terminal of the Dimmer Switch is connected to the Headlight switch.
2. The terminal on the right side is connected to your headlight high beam terminal.
3. The terminal on the left side is connected to your headlight low beam terminal.

another wiring product by...



150 Heller Pl #17 W Bellmawr, NJ 08031 856-933-0801

PART #

500042

DESCRIPTION:

DIMMER SWITCH

92964573 instruction sheet Rev 3.0 6/29/99

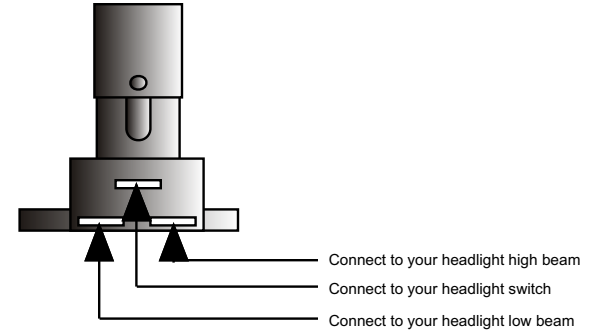

Connect the Dimmer Switch wires as shown above.

1. The top center terminal of the Dimmer Switch is connected to the Headlight switch.
2. The terminal on the right side is connected to your headlight high beam terminal.
3. The terminal on the left side is connected to your headlight low beam terminal.

another wiring product by...



150 Heller Pl #17 W Bellmawr, NJ 08031 856-933-0801

PART #

500042

DESCRIPTION:

DIMMER SWITCH

92964573 instruction sheet Rev 3.0 6/29/99